



PRODUCT CATALOGUE

TABLE OF CONTENTS

Services 2



SERVICES

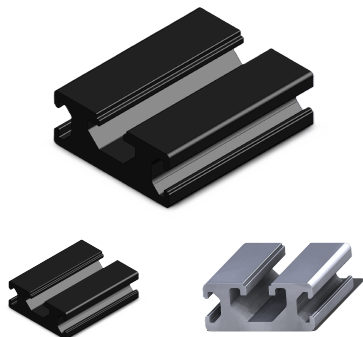

16X40 T-SLOT ALUMINIUM PROFILE | 8MM & 6MM SLOTS | BLACK | GAP ENGINEERING

Price per meter

Product code: TS-1640-6-8-3-B

Colour: Black anodized

Bar Length: 5800 mm

[Read More](#)

SKU: N/A

Price: \$28.24 Ex GST

Categories: [40 Series](#), [T Slot profile and accessories](#)

Tags: [1640](#), [40 Series](#), [8mm Slot](#), [Aluminium Extrusion](#), [NEW](#), [Roll in Spring Nut](#), [T-Slot](#)

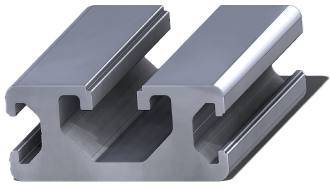

16X40 T-SLOT ALUMINIUM PROFILE | 8MM & 6MM SLOTS | GAP ENGINEERING

Price per meter

Product code: TS-1640-6-8-3

Colour: Silver anodized

Bar Length: 5800 mm

[Read More](#)

SKU: N/A

Price: \$21.54 Ex GST

Categories: [40 Series](#), [T Slot profile and accessories](#)

Tags: [1640](#), [40 Series](#), [8mm Slot](#), [Aluminium Extrusion](#), [NEW](#), [Roll in Spring Nut](#), [T-Slot](#)



PROFILE 20X20 - 6MM SLOT ANODISED BLACK

Price per meter

Product code: TS-2020-6-4-B

Colour: Black anodised

Bar length: 5800mm

[Read More](#)

SKU: N/A

Price: \$16.50 Ex GST per Meter

Categories: [20 Series](#), [T slot Aluminium Profiles](#), [T Slot profile and accessories](#)

Tags: [20 Series](#), [2020](#), [6mm Slot](#), [Aluminium Extrusion](#), [Mat Black](#), [T-Slot](#)

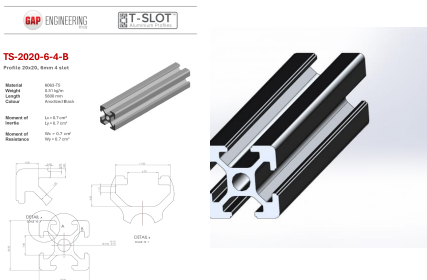

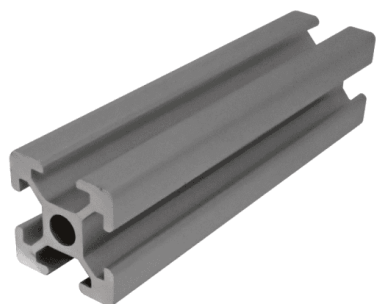

PROFILE 20X20 - 6MM SLOT ANODISED CLEAR

Price per meter

Product code: TS-2020-6-4

Colour: Natural anodised

Bar length: 5800mm

[Read More](#)

SKU: N/A

Price: \$13.20 Ex GST per Meter

Categories: [20 Series](#), [T slot Aluminium Profiles](#), [T Slot profile and accessories](#)

Tags: [20 Series](#), [2020](#), [6mm Slot](#), [Aluminium Extrusion](#), [T-Slot](#)

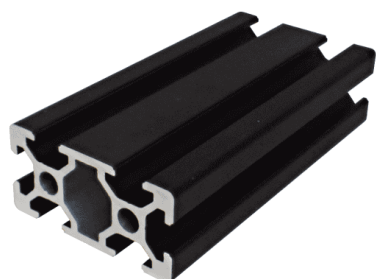
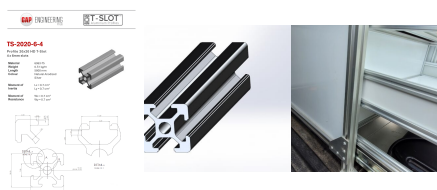

PROFILE 20X40 - 6MM SLOT ANODISED BLACK

Price per meter

Product code: TS-2040-6-6-B

Colour: Black anodised

Bar length: 5800mm

[Read More](#)

SKU: N/A

Price: \$23.20 Ex GST per Meter

Categories: [20 Series](#), [T slot Aluminium Profiles](#), [T Slot profile and accessories](#)

Tags: [20 Series](#), [2040](#), [6mm Slot](#), [Aluminium Extrusion](#), [Mat Black](#), [T-Slot](#)



PROFILE 20X40 - 6MM SLOT ANODISED CLEAR

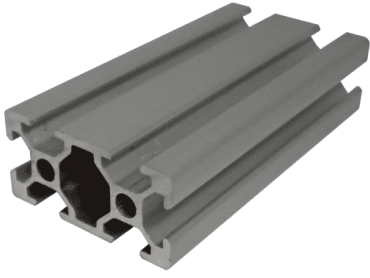

Price per meter

Product code: TS-2040-6-6

Colour: Natural anodized

Bar Length: 5800 mm

[Read More](#)

SKU: N/A

Price: \$20.40 Ex GST per Meter

Categories: [20 Series](#), [T slot Aluminium Profiles](#), [T Slot profile and accessories](#)

Tags: [20 Series](#), [2040](#), [6mm Slot](#), [Aluminium Extrusion](#), [T-Slot](#)

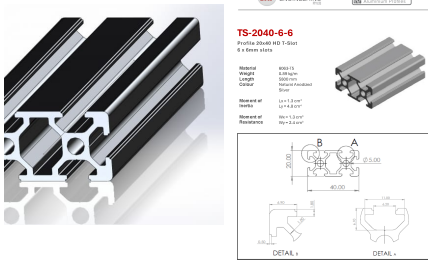

PROFILE 20X60 - 6MM SLOT ANODISED CLEAR

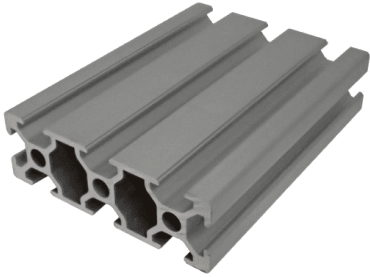

Price per meter

Product code: TS-2060-6-8

Colour: Natural anodized

Bar Length: 5800 mm

[Read More](#)

SKU: N/A

Price: \$24.76 Ex GST per Meter

Categories: [20 Series](#), [T slot Aluminium Profiles](#), [T Slot profile and accessories](#)

Tags: [20 Series](#), [2060](#), [6mm Slot](#), [Aluminium Extrusion](#), [Special Order](#), [T-Slot](#)

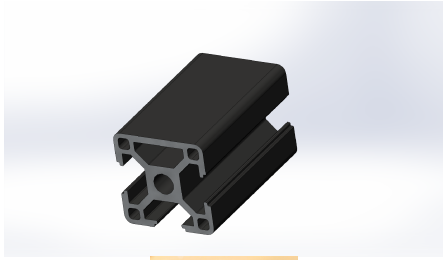

PROFILE 30X30 - 8MM 3-SLOT ANODISED BLACK

Price per meter

Product code: TS-3030-8-3-B

Colour: Black anodised

Bar Length: 5800 mm

[Read More](#)

SKU: T30.3030-3-8-B

Price: \$21.80 Ex GST per Meter

Categories: [30 Series](#), [T slot Aluminium Profiles](#), [T Slot profile and accessories](#)

Tags: [30 Series](#), [3030](#), [8mm Slot](#), [Aluminium Extrusion](#), [black anodized aluminium extrusion](#), [T-Slot](#)

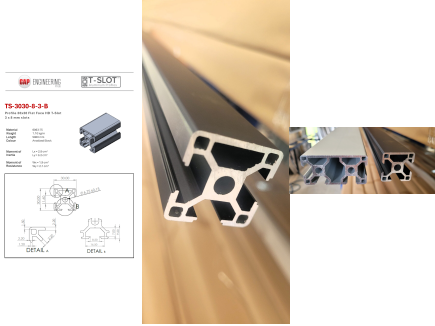

PROFILE 30X30 - 8MM 3-SLOT ANODISED CLEAR

Price per meter

Product code: TS-3030-8-3

Colour: Natural anodized

Bar Length: 5800 mm

[Read More](#)

SKU: T30.3030.4.GAP-5

Price: \$20.80 Ex GST per Meter

Categories: [30 Series](#), [T slot Aluminium Profiles](#), [T Slot profile and accessories](#)

Tags: [30 Series](#), [3030](#), [8mm Slot](#), [Aluminium Extrusion](#), [T-Slot](#)



TS-3030-8-3

Profile 30x30 Flat Face HD T-Slot
3 x 8 mm slots

Material 6063-T5
Weight 1.10 kg/m
Length 5800mm
Colour Natural Anodized Silver

Moment of Inertia Lx = 2.8 cm⁴
Ly = 3.2 cm⁴

Moment of Resistance Wx = 1.9 cm³
Wy = 2.1 cm³

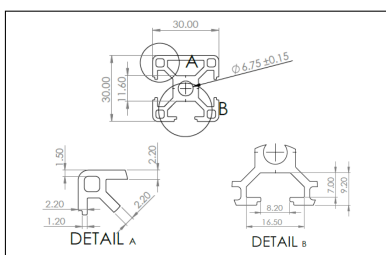
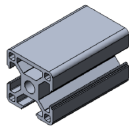

PROFILE 30X60 - 8MM 4-SLOT CLOSED FACE ANODISED CLEAR

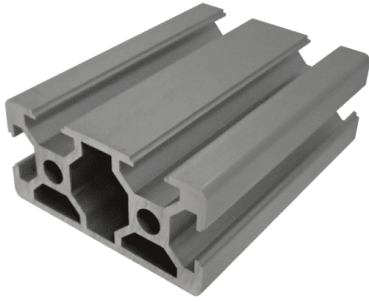

Price per meter

Product code: TS-3060-8-4

Colour: Natural anodized

Bar Length: 5800 mm

[Read More](#)

SKU: T30.3060.4.GAP-1

Price: \$38.75 Ex GST per Meter

Categories: [30 Series](#), [T slot Aluminium Profiles](#), [T Slot profile and accessories](#)

Tags: [30 Series](#), [3060](#), [8mm Slot](#), [Aluminium Extrusion](#), [T-Slot](#)

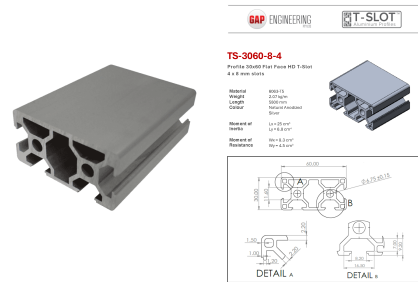

PROFILE 30X60 - 8MM SLOT ANODISED BLACK

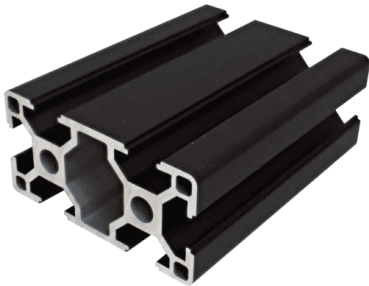

Price per meter

Product code: TS-3060-8-6-B

Colour: Black anodised

Bar Length: 5800 mm

[Read More](#)

SKU: T30.3060.6.GAP-2

Price: \$39.51 Ex GST per Meter

Categories: [30 Series](#), [T slot Aluminium Profiles](#), [T Slot profile and accessories](#)

Tags: [30 Series](#), [3060](#), [8mm Slot](#), [Aluminium Extrusion](#), [Mat Black](#), [T-Slot](#)

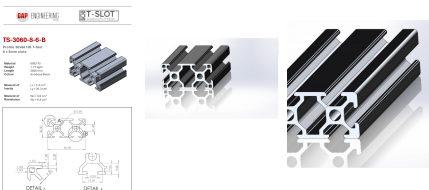

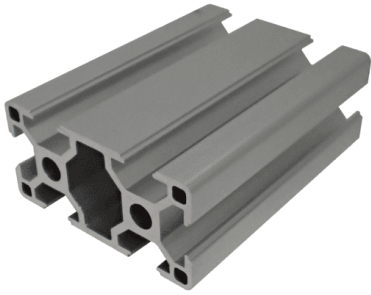

PROFILE 30X60 - 8MM SLOT ANODISED CLEAR

Price per meter

Product code: TS-3060-8-6

Colour: Natural anodized

Bar Length: 5800 mm

[Read More](#)

SKU: T30.3060.6.GAP

Price: \$36.80 Ex GST per Meter

Categories: [30 Series](#), [T slot Aluminium Profiles](#), [T Slot profile and accessories](#)

Tags: [30 Series](#), [3060](#), [8mm Slot](#), [Aluminium Extrusion](#), [T-Slot](#)

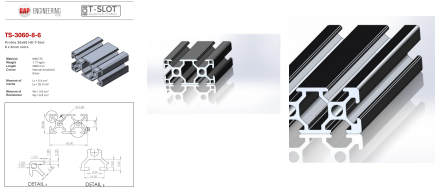

PROFILE 40X120 - 8MM SLOT ANODISED CLEAR

Price per meter

Product code: TS-40120-8-8

Colour: Natural anodized

Bar Length: 5800 mm

[Read More](#)

SKU: N/A

Price: \$87.29 Ex GST per Meter

Categories: [40 Series](#), [T slot Aluminium Profiles](#), [T Slot profile and accessories](#)

Tags: [40 Series](#), [40120](#), [8mm Slot](#), [Aluminium Extrusion](#), [Special Order](#), [T-Slot](#)

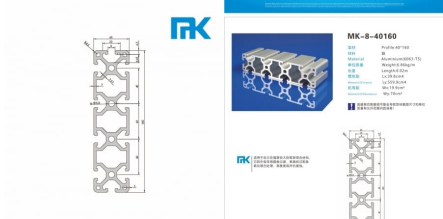



PROFILE 40X160 - 8MM SLOT ANODISED BLACK

Price per meter

Product code: TS-40160-8-10-B

Colour: Black anodised

Bar Length: 5800 mm

[Read More](#)

SKU: N/A

Price: \$139.82 Ex GST per Meter

Categories: [40 Series](#), [T slot Aluminium Profiles](#), [T Slot profile and accessories](#)

Tags: [40 Series](#), [40160](#), [8mm Slot](#), [Aluminium Extrusion](#), [Mat Black](#), [Special Order](#), [T-Slot](#)



PROFILE 40X40 - 8 MM 2-SLOT HALF CLOSED ANODISED CLEAR

Price per meter

Product code: TS-4040-8-2

Colour: Natural anodized

Bar Length: 5800 mm

[Read More](#)

SKU: N/A

Price: \$36.43 Ex GST per Meter

Categories: [40 Series](#), [T slot Aluminium Profiles](#), [T Slot profile and accessories](#)

Tags: [40 Series](#), [4040](#), [8mm Slot](#), [Aluminium Extrusion](#), [Special Order](#), [T-Slot](#)

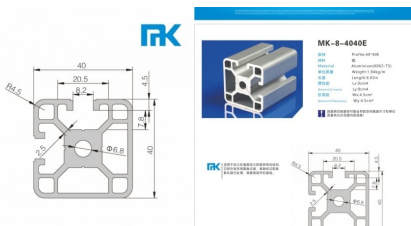



PROFILE 40X40 - 8MM 3-SLOT CLOSED FACE ANODISED CLEAR

Price per meter

Product code: TS-4040-8-3

Colour: Natural anodized

Bar Length: 5800 mm

[Read More](#)

SKU: N/A

Price: \$36.04 Ex GST per Meter

Categories: [40 Series](#), [T slot Aluminium Profiles](#), [T Slot profile and accessories](#)

Tags: [40 Series](#), [4040](#), [8mm Slot](#), [Aluminium Extrusion](#), [Special Order](#), [T-Slot](#)



PROFILE 40X40 - 8MM SLOT ANODISED BLACK

Price per meter

Product code: TS-B-4040-8-4-B

Colour: Anodised Black

Bar Length: 5800 mm

[Read More](#)

SKU: N/A

Price: \$39.50 Ex GST per Meter

Categories: [40 Series](#), [T slot Aluminium Profiles](#), [T Slot profile and accessories](#)

Tags: [40 Series](#), [4040](#), [Aluminium Extrusion](#), [T-Slot](#)



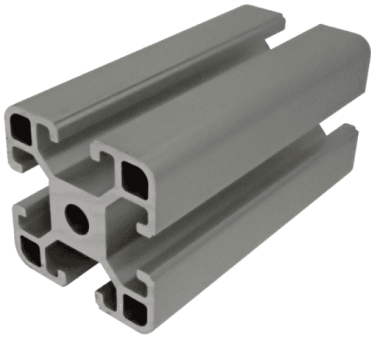

PROFILE 40X40 - 8MM SLOT ANODISED CLEAR

Price per meter

Product code: TS-B-4040-8-4

Colour: Natural anodized

Bar Length: 5800 mm

[Read More](#)

SKU: N/A

Price: \$33.00 Ex GST per Meter

Categories: [40 Series](#), [T slot Aluminium Profiles](#), [T Slot profile and accessories](#)

Tags: [40 Series](#), [4040](#), [Aluminium Extrusion](#), [NEW](#), [T-Slot](#)



PROFILE 40X40 R - 8MM SLOT ANODISED CLEAR

Price per meter

Product code: TS-R-4040-8-2

Colour: Natural anodized

Bar Length: 5800 mm

[Read More](#)

SKU: N/A

Price: \$35.45 Ex GST per Meter

Categories: [40 Series](#), [T slot Aluminium Profiles](#), [T Slot profile and accessories](#)

Tags: [40 Series](#), [4040](#), [8mm Slot](#), [Aluminium Extrusion](#), [Round Profile](#), [T-Slot](#)

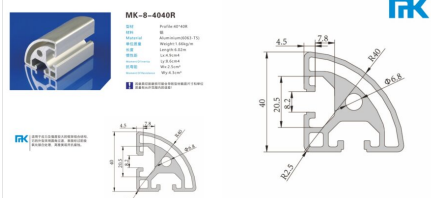



PROFILE 40X80 - 8MM SLOT ANODISED BLACK

Price per meter

Product code: TS-4080-8-6-B

Colour: Black anodised

Bar Length: 5800 mm

[Read More](#)

SKU: N/A

Price: \$60.55 Ex GST

Categories: [40 Series](#), [T Slot profile and accessories](#)

Tags: [40 Series](#), [4080](#), [8mm Slot](#), [Aluminium Extrusion](#), [Mat Black](#), [T-Slot](#)

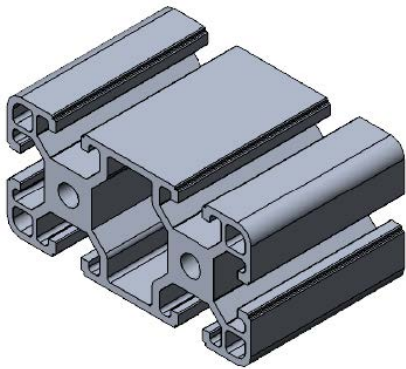
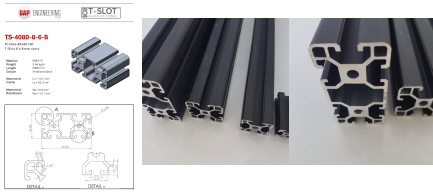

PROFILE 40X80 - 8MM SLOT ANODISED CLEAR

Price per meter

Product code: TS-4080-8-6

Colour: Natural anodized

Bar Length: 5800 mm

[Read More](#)

SKU: N/A

Price: \$57.22 Ex GST per Meter

Categories: [40 Series](#), [T slot Aluminium Profiles](#), [T Slot profile and accessories](#)

Tags: [40 Series](#), [4080](#), [8mm Slot](#), [Aluminium Extrusion](#), [T-Slot](#)

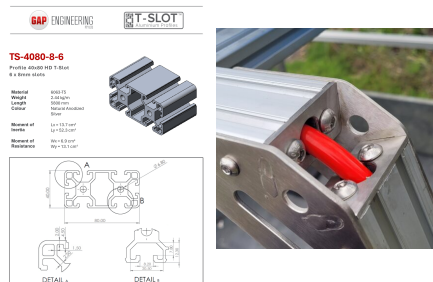



PROFILE 45X45 10MM SLOT ANODISED BLACK

Price per meter

Product Code : TS-4545-10-4-B

Colour : Anodised Black

Bar Length : 5800 mm

[Read More](#)

SKU: ALS.084.101.012-1

Price: \$42.85 Ex GST per Meter

Categories: [45 Series](#), [T slot Aluminium Profiles](#), [T Slot profile and accessories](#)

Tags: [10mm Slot](#), [45 Series](#), [4545](#), [Aluminium Extrusion](#), [T-Slot](#)

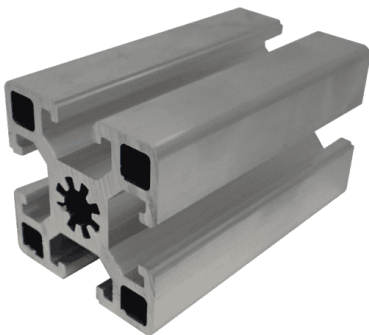
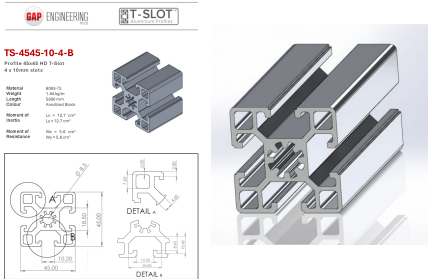

PROFILE 45X45 10MM SLOT ANODISED CLEAR

Price per meter

Product Code : TS-4545-10-4

Colour : Natural Anodised

Bar Length : 5800 mm

[Read More](#)

SKU: ALS.084.101.012

Price: \$41.27 Ex GST per Meter

Categories: [45 Series](#), [T slot Aluminium Profiles](#), [T Slot profile and accessories](#)

Tags: [10mm Slot](#), [45 Series](#), [4545](#), [Aluminium Extrusion](#), [T-Slot](#)

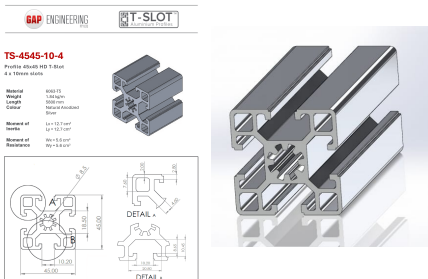



PROFILE 45X90 10MM SLOT ANODISED BLACK

Price per meter

Product Code: TS-4590-10-6-B

Colour: Anodised Black

Bar Length: 5800 mm

[Read More](#)

SKU: N/A

Price: \$75.60 Ex GST per Meter

Categories: [45 Series](#), [T slot Aluminium Profiles](#), [T Slot profile and accessories](#)

Tags: [10mm Slot](#), [45 Series](#), [4590](#), [Aluminium Extrusion](#), [T-Rax Cargo System](#), [T-Slot](#)

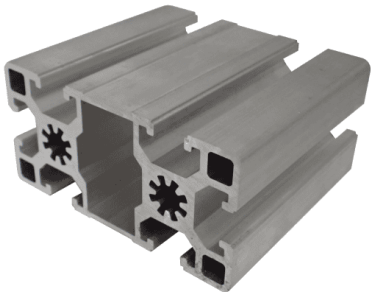
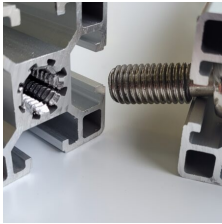
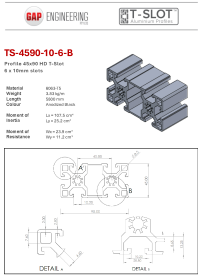

PROFILE 45X90 10MM SLOT ANODISED CLEAR

Price per meter

Product Code: TS-4590-10-6

Colour: Natural anodised

Bar Length: 5800 mm

[Read More](#)

SKU: N/A

Price: \$72.60 Ex GST per Meter

Categories: [45 Series](#), [T slot Aluminium Profiles](#), [T Slot profile and accessories](#)

Tags: [10mm Slot](#), [45 Series](#), [4590](#), [Aluminium Extrusion](#), [T-Rax Cargo System](#), [T-Slot](#)

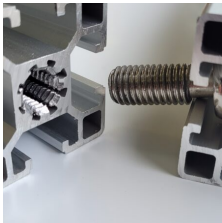
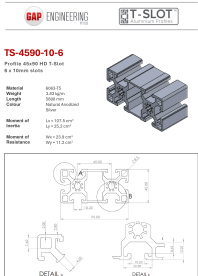

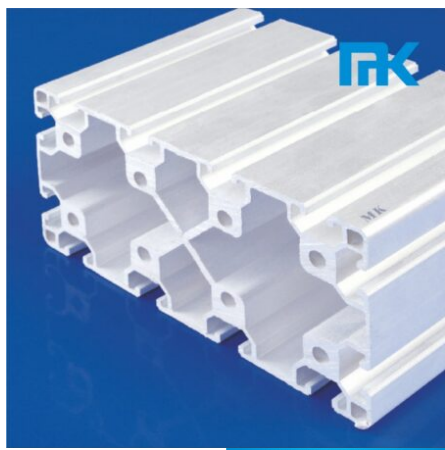

PROFILE 80X160 - 8MM SLOT ANODISED CLEAR

Price per meter

Product code: TS-80160-8-12

Colour: Natural anodized

Bar Length: 5800 mm

[Read More](#)

SKU: N/A

Price: \$178.20 Ex GST per Meter

Categories: [40 Series](#), [T slot Aluminium Profiles](#), [T Slot profile and accessories](#)

Tags: [40 Series](#), [80160](#), [8mm Slot](#), [Aluminium Extrusion](#), [Special Order](#), [T-Slot](#)

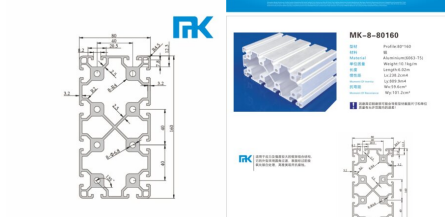

INDEX

1

16x40 T-Slot Aluminium Profile | 8mm & 6mm Slots | Black | GAP Engineering 2

16x40 T-Slot Aluminium Profile | 8mm & 6mm Slots | GAP Engineering 3

P

Profile 20x20 - 6mm slot Anodised Black 3

Profile 20x20 - 6mm slot Anodised Clear 4

Profile 20x40 - 6mm slot Anodised Black 4

Profile 20x40 - 6mm slot Anodised Clear 5

Profile 20x60 - 6mm slot Anodised Clear 5

Profile 20x80 - 6mm slot Anodised Clear 6

Profile 30x120 - 8mm slot Anodised Clear 6

Profile 30x30 - 8mm 3-slot Anodised Black 7

Profile 30x30 - 8mm 3-slot Anodised Clear 7

Profile 30x30 - 8mm slot Anodised Black 8

Profile 30x30 - 8mm slot Anodised Clear 8

Profile 30x30R - 8mm slot Anodised Clear 9

Profile 30x60 - 8mm 4-slot closed face Anodised Black 9

Profile 30x60 - 8mm 4-slot closed face Anodised Clear 10

Profile 30x60 - 8mm slot Anodised Black 10

Profile 30x60 - 8mm slot Anodised Clear 11

Profile 40x120 - 8mm slot Anodised Clear 11

Profile 40x160 - 8mm slot Anodised Black 12

Profile 40x40 - 8 mm 2-slot half closed Anodised Clear 12

Profile 40x40 - 8mm 3-slot closed face Anodised Clear 13

Profile 40x40 - 8mm slot Anodised Black 13

Profile 40x40 - 8mm slot Anodised Clear 14

Profile 40x40 R - 8mm slot Anodised Clear 14

Profile 40x80 - 8mm slot Anodised Black 15

Profile 40x80 - 8mm slot Anodised Clear 15

Profile 45x45 10mm slot Anodised Black 16

Profile 45x45 10mm slot Anodised Clear 16

Profile 45x90 10mm slot Anodised Black 17

Profile 45x90 10mm slot Anodised Clear 17

Profile 80x160 - 8mm slot Anodised Clear 18