



---

# PRODUCT CATALOGUE

# TABLE OF CONTENTS

<b>20 Series</b> .....	<b>2</b>
------------------------	----------



## 20 SERIES

# 20 SERIES EXTRUDED ALUMINIUM T SLOT PROFILE

To order cut lengths of a profile please fill in the form in the [cutting service page](#).

Our profile come in 5.8-meter lengths

All prices indicated are **per meter**

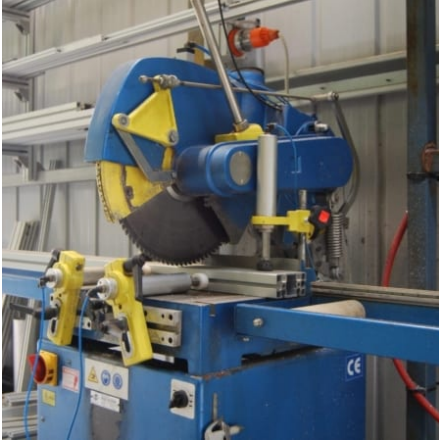

## CUTTING SERVICE

Cutting accurately and neatly is crucial for getting a great result when using T Slot Extrusions.

Complete the cutting list below and we will prepare your material for you.

**Click the + at the end of the line to add a new line**

Transport costs are reduced according to the length of the goods.

[Read More](#)

**SKU:** N/A

**Price:** \$3.25 Ex GST

**Categories:** [20 Series](#), [30 Series](#), [40 Series](#), [45 Series](#), [Services](#)



## DRILLING AND TAPPING SERVICE

Drill and tapping in the correct positions for easy assembly of your project.

[Read More](#)

**SKU:** N/A

**Price:** \$4.25 Ex GST

**Categories:** [20 Series](#), [30 Series](#), [40 Series](#), [45 Series](#), [Services](#), [T Slot profile and accessories](#)



## PROFILE 20X20 - 6MM SLOT ANODISED BLACK

Price per meter

**Product code:** TS-2020-6-4-B

**Colour:** Black anodised

**Bar length:** 5800mm

[Read More](#)

**SKU:** N/A

**Price:** \$16.50 Ex GST per Meter

**Categories:** [20 Series](#), [T slot Aluminium Profiles](#), [T Slot profile and accessories](#)

**Tags:** [20 Series](#), [2020](#), [6mm Slot](#), [Aluminium Extrusion](#), [Mat Black](#), [T-Slot](#)

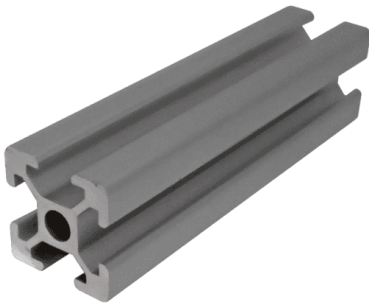

## PROFILE 20X20 - 6MM SLOT ANODISED CLEAR

Price per meter

**Product code:** TS-2020-6-4

**Colour:** Natural anodised

**Bar length:** 5800mm

[Read More](#)

**SKU:** N/A

**Price:** \$13.20 Ex GST per Meter

**Categories:** [20 Series](#), [T slot Aluminium Profiles](#), [T Slot profile and accessories](#)

**Tags:** [20 Series](#), [2020](#), [6mm Slot](#), [Aluminium Extrusion](#), [T-Slot](#)



## PROFILE 20X40 - 6MM SLOT ANODISED BLACK

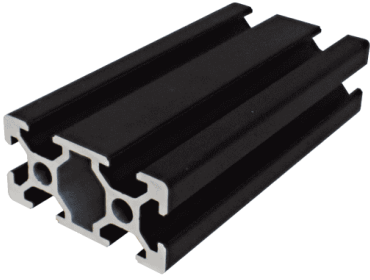

Price per meter

**Product code:** TS-2040-6-6-B

**Colour:** Black anodised

**Bar length:** 5800mm

[Read More](#)

**SKU:** N/A

**Price:** \$23.20 Ex GST per Meter

**Categories:** [20 Series](#), [T slot Aluminium Profiles](#), [T Slot profile and accessories](#)

**Tags:** [20 Series](#), [2040](#), [6mm Slot](#), [Aluminium Extrusion](#), [Mat Black](#), [T-Slot](#)

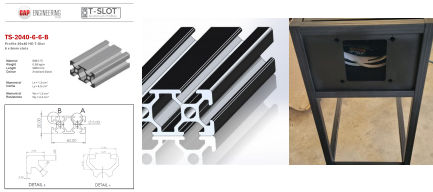

## PROFILE 20X40 - 6MM SLOT ANODISED CLEAR

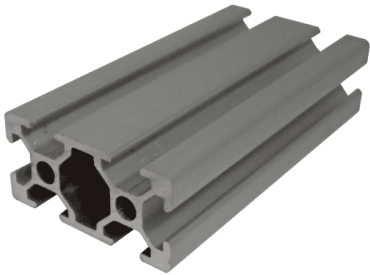

Price per meter

**Product code:** TS-2040-6-6

**Colour:** Natural anodized

**Bar Length:** 5800 mm

[Read More](#)

**SKU:** N/A

**Price:** \$20.40 Ex GST per Meter

**Categories:** [20 Series](#), [T slot Aluminium Profiles](#), [T Slot profile and accessories](#)

**Tags:** [20 Series](#), [2040](#), [6mm Slot](#), [Aluminium Extrusion](#), [T-Slot](#)

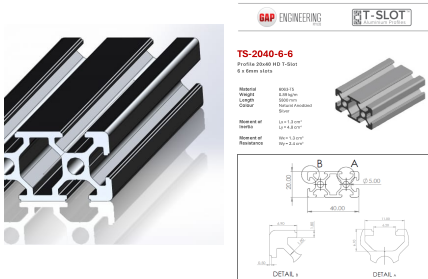

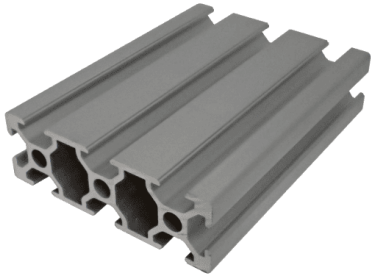

## PROFILE 20X60 - 6MM SLOT ANODISED CLEAR

Price per meter

**Product code:** TS-2060-6-8

**Colour:** Natural anodized

**Bar Length:** 5800 mm

[Read More](#)

**SKU:** N/A

**Price:** \$24.76 Ex GST per Meter

**Categories:** [20 Series](#), [T slot Aluminium Profiles](#), [T Slot profile and accessories](#)

**Tags:** [20 Series](#), [2060](#), [6mm Slot](#), [Aluminium Extrusion](#), [Special Order](#), [T-Slot](#)

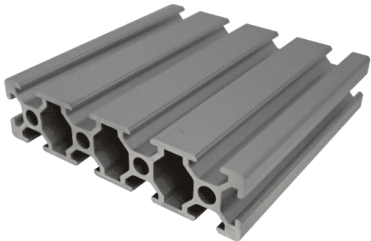

## PROFILE 20X80 - 6MM SLOT ANODISED CLEAR

Price per meter

**Product code:** TS-2080-6-10

**Colour:** Natural anodized

**Bar Length:** 5800 mm

[Read More](#)

**SKU:** N/A

**Price:** \$30.70 Ex GST per Meter

**Categories:** [20 Series](#), [Accessories](#), [T slot Aluminium Profiles](#)

**Tags:** [20 Series](#), [2080](#), [6mm Slot](#), [Aluminium Extrusion](#), [Special Order](#), [T-Slot](#)

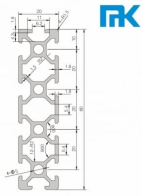

# INDEX

## C

Cutting service 3

## D

Drilling and tapping service 3

## P

Profile 20x20 - 6mm slot Anodised Black 4

Profile 20x20 - 6mm slot Anodised Clear 4

Profile 20x40 - 6mm slot Anodised Black 5

Profile 20x40 - 6mm slot Anodised Clear 5

Profile 20x60 - 6mm slot Anodised Clear 6

Profile 20x80 - 6mm slot Anodised Clear 6