

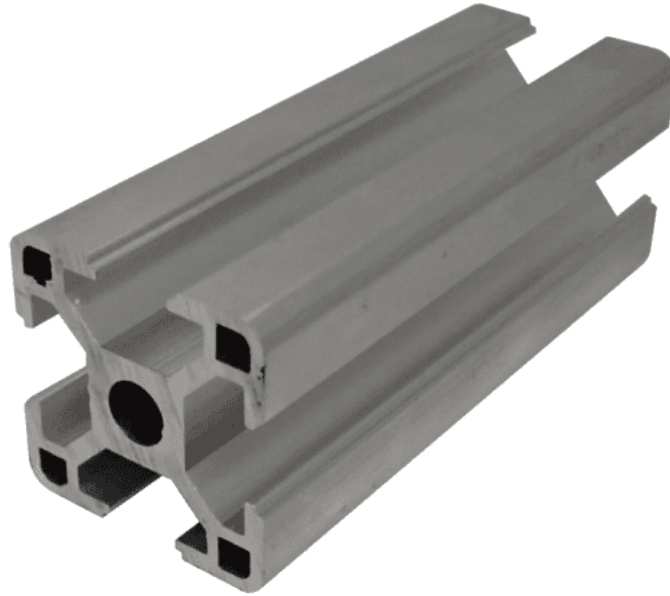

PRODUCT CATALOGUE

TABLE OF CONTENTS

30 Series	2
------------------------	----------



30 SERIES

30 SERIES T SLOT EXTRUDED ALUMINIUM PROFILES

To order cut lengths of a profile please fill in the form in the [cutting service page](#).

Our profile come in 5.8-meter lengths

All prices indicated are **per meter**

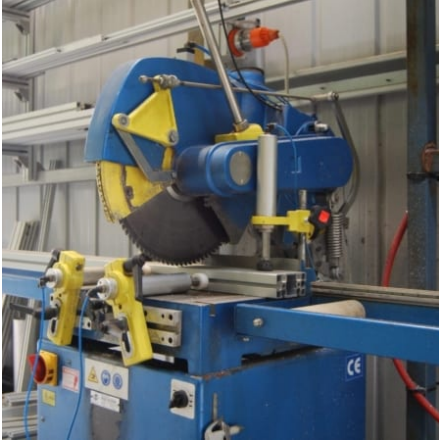

CUTTING SERVICE

Cutting accurately and neatly is crucial for getting a great result when using T Slot Extrusions.

Complete the cutting list below and we will prepare your material for you.

Click the + at the end of the line to add a new line

Transport costs are reduced according to the length of the goods.

[Read More](#)

SKU: N/A

Price: \$3.25 Ex GST

Categories: [20 Series](#), [30 Series](#), [40 Series](#), [45 Series](#), [Services](#)



DRILLING AND TAPPING SERVICE

Drill and tapping in the correct positions for easy assembly of your project.

[Read More](#)

SKU: N/A

Price: \$4.25 Ex GST

Categories: [20 Series](#), [30 Series](#), [40 Series](#), [45 Series](#), [Services](#), [T Slot profile and accessories](#)

PROFILE 30X120 - 8MM SLOT ANODISED CLEAR

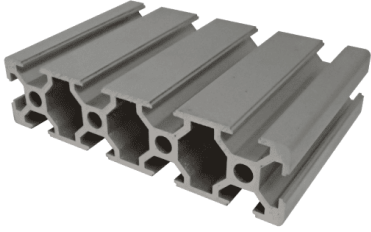

Price per meter

Product code: TS-30120-8-10

Colour: Natural anodized

Bar Length: 5800 mm

[Read More](#)

SKU: T30.3030.4.GAP-1

Price: \$69.30 Ex GST per Meter

Categories: [30 Series](#), [T slot Aluminium Profiles](#), [T Slot profile and accessories](#)

Tags: [30 Series](#), [30120](#), [8mm Slot](#), [Aluminium Extrusion](#), [Special Order](#), [T-Slot](#)

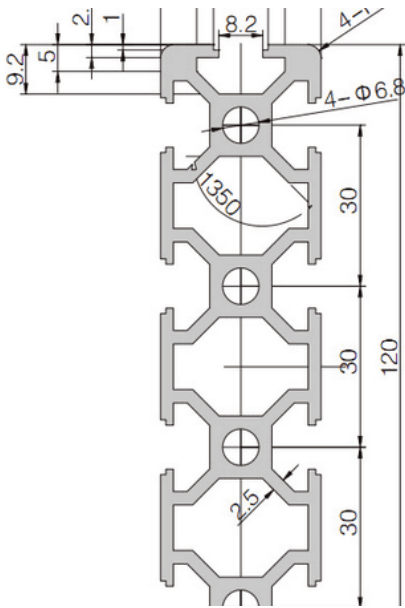

PROFILE 30X30 - 8MM 3-SLOT ANODISED BLACK

Price per meter

Product code: TS-3030-8-3-B

Colour: Black anodised

Bar Length: 5800 mm

[Read More](#)

SKU: T30.3030-3-8-B

Price: \$21.80 Ex GST per Meter

Categories: [30 Series](#), [T slot Aluminium Profiles](#), [T Slot profile and accessories](#)

Tags: [30 Series](#), [3030](#), [8mm Slot](#), [Aluminium Extrusion](#), [black anodized aluminium extrusion](#), [T-Slot](#)

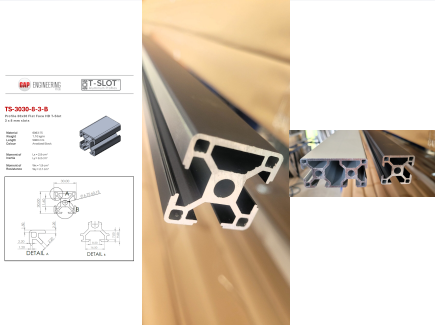
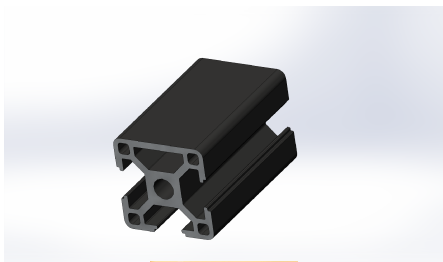



PROFILE 30X30 - 8MM 3-SLOT ANODISED CLEAR

Price per meter

Product code: TS-3030-8-3

Colour: Natural anodized

Bar Length: 5800 mm

[Read More](#)

SKU: T30.3030.4.GAP-5

Price: \$20.80 Ex GST per Meter

Categories: [30 Series](#), [T slot Aluminium Profiles](#), [T Slot profile and accessories](#)

Tags: [30 Series](#), [3030](#), [8mm Slot](#), [Aluminium Extrusion](#), [T-Slot](#)



TS-3030-8-3

Profile 30x30 Flat Face HD T-Slot
3 x 8 mm slots

Material: 6063-T5
Weight: 1.10 kg/m
Length: 5800 mm
Colour: Natural Anodized Silver

Moment of Inertia: Lx = 2.9 cm⁴
Ly = 3.2 cm⁴

Moment of Resistance: Wx = 1.9 cm³
Wy = 2.1 cm³

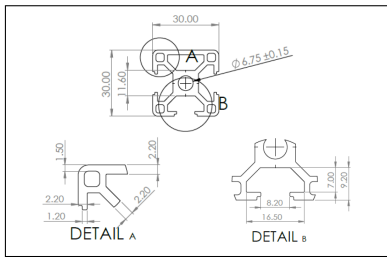
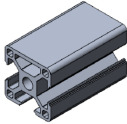

PROFILE 30X30 - 8MM SLOT ANODISED BLACK

Price per meter

Product code: TS-3030-8-4-B

Colour: Black anodised

Bar Length: 5800 mm

[Read More](#)

SKU: T30.3030.4.GAP-4

Price: \$20.80 Ex GST per Meter

Categories: [30 Series](#), [T slot Aluminium Profiles](#), [T Slot profile and accessories](#)

Tags: [30 Series](#), [3030](#), [8mm Slot](#), [Aluminium Extrusion](#), [Mat Black](#), [T-Slot](#)



TS-3030-8-4-B

Profile 30x30 HD T-Slot
1 x 8 mm slot

Material: 6063-T5
Weight: 0.57 kg/m
Length: 5800 mm
Colour: Anodized Black

Moment of Inertia: Lx = 1.4 cm⁴
Ly = 1.4 cm⁴

Moment of Resistance: Wx = 1.0 cm³
Wy = 1.0 cm³

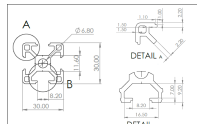
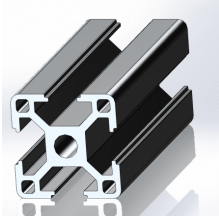



PROFILE 30X30 - 8MM SLOT ANODISED CLEAR

Price per meter

Product code: TS-3030-8-4

Colour: Natural anodized

Bar Length: 5800 mm

[Read More](#)

SKU: T30.3030.4.GAP

Price: \$17.85 Ex GST per Meter

Categories: [30 Series](#), [T slot Aluminium Profiles](#), [T Slot profile and accessories](#)

Tags: [30 Series](#), [3030](#), [8mm Slot](#), [Aluminium Extrusion](#), [T-Slot](#)

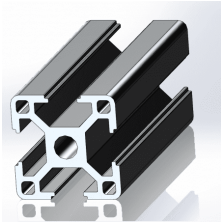
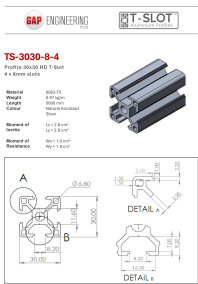

PROFILE 30X30R - 8MM SLOT ANODISED CLEAR

Price per meter

Product code: TS-R-3030-8-2

Colour: Natural anodized

Bar Length: 5800 mm

[Read More](#)

SKU: T30.3030.4.GAP-2

Price: \$17.55 Ex GST per Meter

Categories: [30 Series](#), [T slot Aluminium Profiles](#), [T Slot profile and accessories](#)

Tags: [30 Series](#), [3030](#), [8mm Slot](#), [Aluminium Extrusion](#), [Round Profile](#), [T-Slot](#)

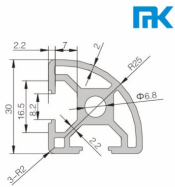

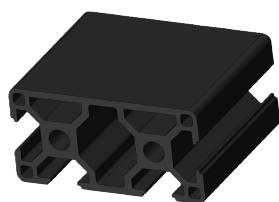

PROFILE 30X60 - 8MM 4-SLOT CLOSED FACE ANODISED BLACK

Price per meter

Product code: TS-3060-8-4-B

Colour: Black anodised

Bar Length: 5800 mm

[Read More](#)

SKU: T30.3060.4.GAP-1-1

Price: \$39.35 Ex GST per Meter

Categories: [30 Series](#), [T slot Aluminium Profiles](#), [T Slot profile and accessories](#)

Tags: [30 Series](#), [3060](#), [8mm Slot](#), [Aluminium Extrusion](#), [T-Slot](#)

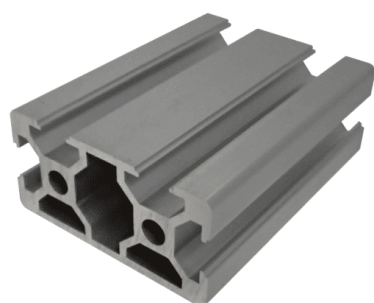
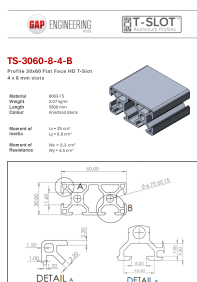

PROFILE 30X60 - 8MM 4-SLOT CLOSED FACE ANODISED CLEAR

Price per meter

Product code: TS-3060-8-4

Colour: Natural anodised

Bar Length: 5800 mm

[Read More](#)

SKU: T30.3060.4.GAP-1

Price: \$38.75 Ex GST per Meter

Categories: [30 Series](#), [T slot Aluminium Profiles](#), [T Slot profile and accessories](#)

Tags: [30 Series](#), [3060](#), [8mm Slot](#), [Aluminium Extrusion](#), [T-Slot](#)

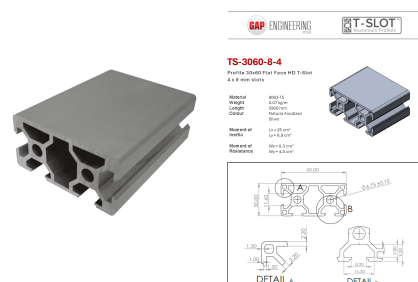

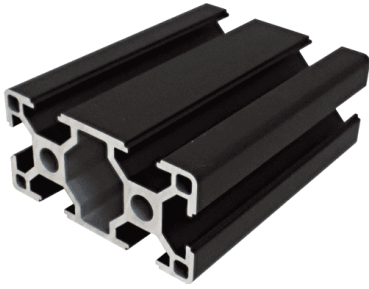

PROFILE 30X60 - 8MM SLOT ANODISED BLACK

Price per meter

Product code: TS-3060-8-6-B

Colour: Black anodised

Bar Length: 5800 mm

[Read More](#)

SKU: T30.3060.6.GAP-2

Price: \$39.51 Ex GST per Meter

Categories: [30 Series](#), [T slot Aluminium Profiles](#), [T Slot profile and accessories](#)

Tags: [30 Series](#), [3060](#), [8mm Slot](#), [Aluminium Extrusion](#), [Mat Black](#), [T-Slot](#)

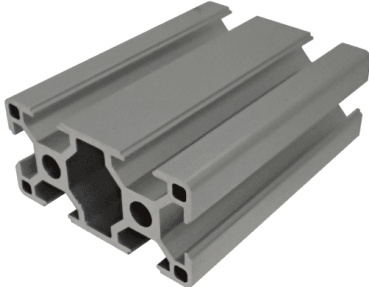
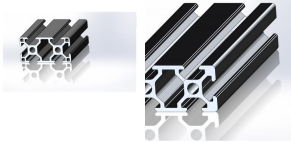
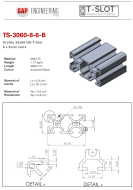

PROFILE 30X60 - 8MM SLOT ANODISED CLEAR

Price per meter

Product code: TS-3060-8-6

Colour: Natural anodized

Bar Length: 5800 mm

[Read More](#)

SKU: T30.3060.6.GAP

Price: \$36.80 Ex GST per Meter

Categories: [30 Series](#), [T slot Aluminium Profiles](#), [T Slot profile and accessories](#)

Tags: [30 Series](#), [3060](#), [8mm Slot](#), [Aluminium Extrusion](#), [T-Slot](#)

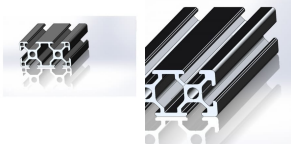
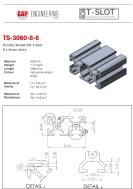

INDEX

C

Cutting service 3

D

Drilling and tapping service 3

P

Profile 30x120 - 8mm slot Anodised Clear 4

Profile 30x30 - 8mm 3-slot Anodised Black 4

Profile 30x30 - 8mm 3-slot Anodised Clear 5

Profile 30x30 - 8mm slot Anodised Black 5

Profile 30x30 - 8mm slot Anodised Clear 6

Profile 30x30R - 8mm slot Anodised Clear 6

Profile 30x60 - 8mm 4-slot closed face Anodised Black 7

Profile 30x60 - 8mm 4-slot closed face Anodised Clear 7

Profile 30x60 - 8mm slot Anodised Black 8

Profile 30x60 - 8mm slot Anodised Clear 8