



---

# PRODUCT CATALOGUE

# TABLE OF CONTENTS

45 Series .....	2
-----------------	---

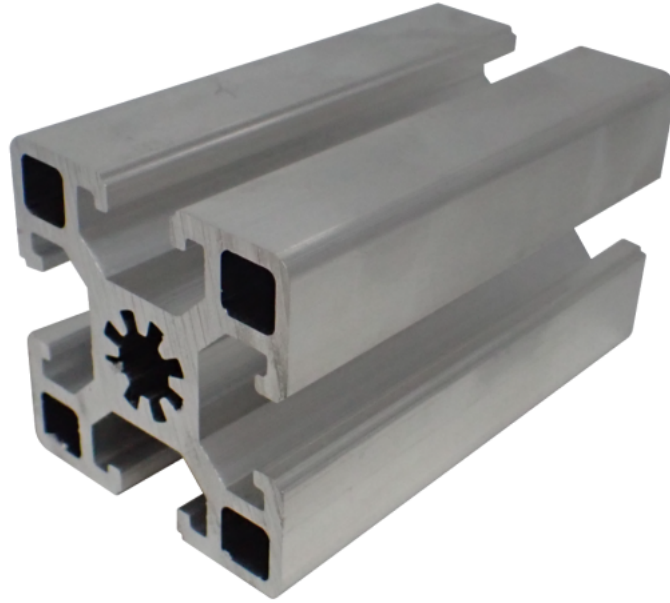

## 45 SERIES

# 45 SERIES T SLOT EXTRUDED ALUMINIUM PROFILES

To order cut lengths of a profile please fill in the form in the [cutting service page](#).

Our profile come in 5.8-meter lengths

All prices indicated are **per meter**

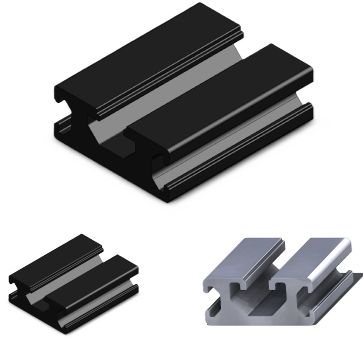

## 16X40 T-SLOT ALUMINIUM PROFILE | 8MM & 6MM SLOTS | BLACK | GAP ENGINEERING

Price per meter

**Product code:** TS-1640-6-8-3-B

**Colour:** Black anodized

**Bar Length:** 5800 mm

[Read More](#)

**SKU:** N/A

**Price:** \$28.24 Ex GST

**Categories:** [40 Series](#), [T Slot profile and accessories](#)

**Tags:** [1640](#), [40 Series](#), [8mm Slot](#), [Aluminium Extrusion](#), [NEW](#), [Roll in Spring Nut](#), [T-Slot](#)

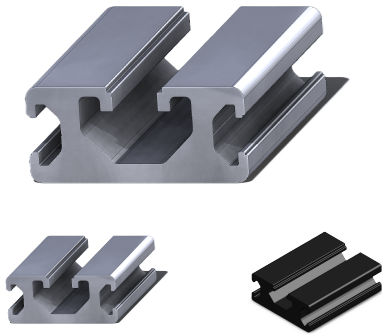

## 16X40 T-SLOT ALUMINIUM PROFILE | 8MM & 6MM SLOTS | GAP ENGINEERING

Price per meter

**Product code:** TS-1640-6-8-3

**Colour:** Silver anodized

**Bar Length:** 5800 mm

[Read More](#)

**SKU:** N/A

**Price:** \$21.54 Ex GST

**Categories:** [40 Series](#), [T Slot profile and accessories](#)

**Tags:** [1640](#), [40 Series](#), [8mm Slot](#), [Aluminium Extrusion](#), [NEW](#), [Roll in Spring Nut](#), [T-Slot](#)



## CUTTING SERVICE

Cutting accurately and neatly is crucial for getting a great result when using T Slot Extrusions.

Complete the cutting list below and we will prepare your material for you.

**Click the + at the end of the line to add a new line**

Transport costs are reduced according to the length of the goods.

[Read More](#)

**SKU:** N/A

**Price:** \$3.25 Ex GST

**Categories:** [20 Series](#), [30 Series](#), [40 Series](#), [45 Series](#), [Services](#)



## DRILLING AND TAPPING SERVICE

Drill and tapping in the correct positions for easy assembly of your project.

[Read More](#)

**SKU:** N/A

**Price:** \$4.25 Ex GST

**Categories:** [20 Series](#), [30 Series](#), [40 Series](#), [45 Series](#), [Services](#), [T Slot profile and accessories](#)

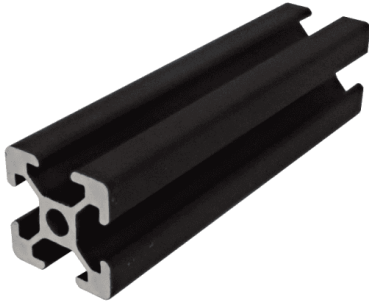

## PROFILE 20X20 - 6MM SLOT ANODISED BLACK

Price per meter

**Product code:** TS-2020-6-4-B

**Colour:** Black anodised

**Bar length:** 5800mm

[Read More](#)

**SKU:** N/A

**Price:** \$16.50 Ex GST per Meter

**Categories:** [20 Series](#), [T slot Aluminium Profiles](#), [T Slot profile and accessories](#)

**Tags:** [20 Series](#), [2020](#), [6mm Slot](#), [Aluminium Extrusion](#), [Mat Black](#), [T-Slot](#)

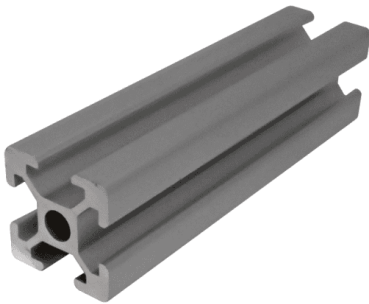
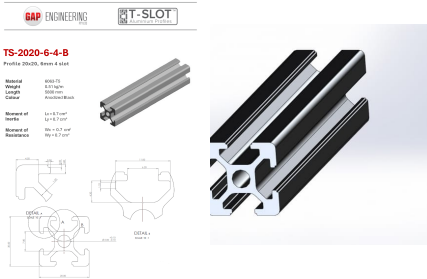

## PROFILE 20X20 - 6MM SLOT ANODISED CLEAR

Price per meter

**Product code:** TS-2020-6-4

**Colour:** Natural anodised

**Bar length:** 5800mm

[Read More](#)

**SKU:** N/A

**Price:** \$13.20 Ex GST per Meter

**Categories:** [20 Series](#), [T slot Aluminium Profiles](#), [T Slot profile and accessories](#)

**Tags:** [20 Series](#), [2020](#), [6mm Slot](#), [Aluminium Extrusion](#), [T-Slot](#)

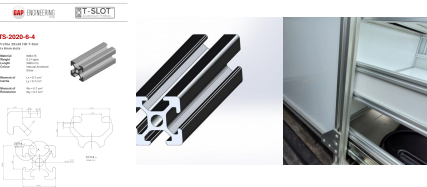

## PROFILE 20X40 - 6MM SLOT ANODISED BLACK

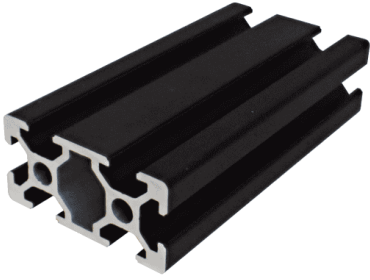

Price per meter

**Product code:** TS-2040-6-6-B

**Colour:** Black anodised

**Bar length:** 5800mm

[Read More](#)

**SKU:** N/A

**Price:** \$23.20 Ex GST per Meter

**Categories:** [20 Series](#), [T slot Aluminium Profiles](#), [T Slot profile and accessories](#)

**Tags:** [20 Series](#), [2040](#), [6mm Slot](#), [Aluminium Extrusion](#), [Mat Black](#), [T-Slot](#)

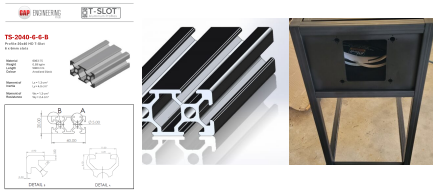

## PROFILE 20X40 - 6MM SLOT ANODISED CLEAR

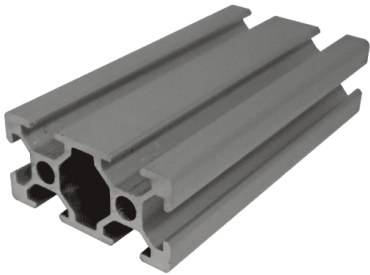

Price per meter

**Product code:** TS-2040-6-6

**Colour:** Natural anodized

**Bar Length:** 5800 mm

[Read More](#)

**SKU:** N/A

**Price:** \$20.40 Ex GST per Meter

**Categories:** [20 Series](#), [T slot Aluminium Profiles](#), [T Slot profile and accessories](#)

**Tags:** [20 Series](#), [2040](#), [6mm Slot](#), [Aluminium Extrusion](#), [T-Slot](#)

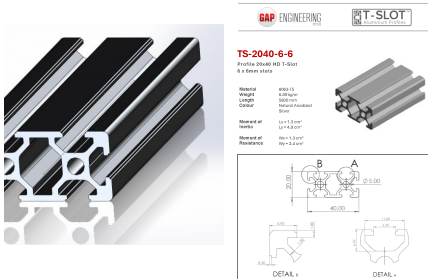

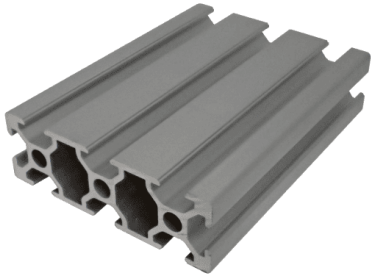

## PROFILE 20X60 - 6MM SLOT ANODISED CLEAR

Price per meter

**Product code:** TS-2060-6-8

**Colour:** Natural anodized

**Bar Length:** 5800 mm

[Read More](#)

**SKU:** N/A

**Price:** \$24.76 Ex GST per Meter

**Categories:** [20 Series](#), [T slot Aluminium Profiles](#), [T Slot profile and accessories](#)

**Tags:** [20 Series](#), [2060](#), [6mm Slot](#), [Aluminium Extrusion](#), [Special Order](#), [T-Slot](#)

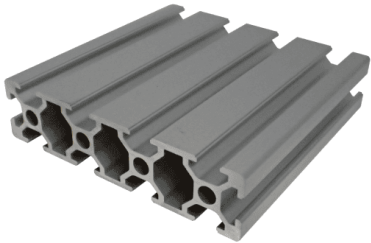

## PROFILE 20X80 - 6MM SLOT ANODISED CLEAR

Price per meter

**Product code:** TS-2080-6-10

**Colour:** Natural anodized

**Bar Length:** 5800 mm

[Read More](#)

**SKU:** N/A

**Price:** \$30.70 Ex GST per Meter

**Categories:** [20 Series](#), [Accessories](#), [T slot Aluminium Profiles](#)

**Tags:** [20 Series](#), [2080](#), [6mm Slot](#), [Aluminium Extrusion](#), [Special Order](#), [T-Slot](#)

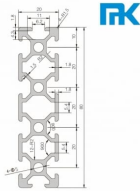

## PROFILE 30X120 - 8MM SLOT ANODISED CLEAR

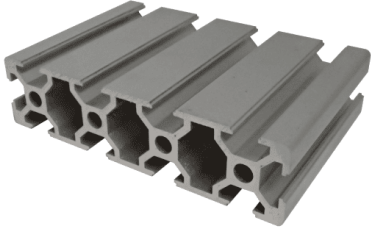

Price per meter

**Product code:** TS-30120-8-10

**Colour:** Natural anodized

**Bar Length:** 5800 mm

[Read More](#)

**SKU:** T30.3030.4.GAP-1

**Price:** \$69.30 Ex GST per Meter

**Categories:** [30 Series](#), [T slot Aluminium Profiles](#), [T Slot profile and accessories](#)

**Tags:** [30 Series](#), [30120](#), [8mm Slot](#), [Aluminium Extrusion](#), [Special Order](#), [T-Slot](#)

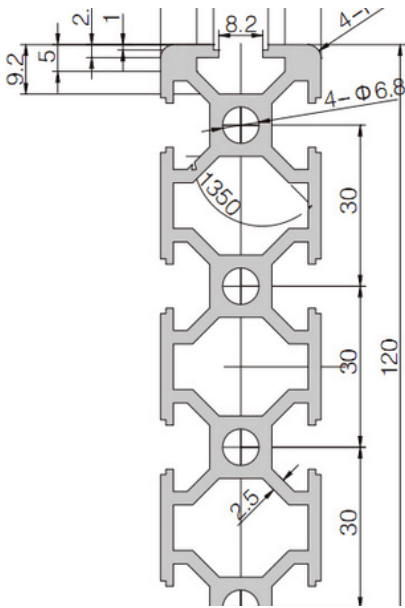

## PROFILE 30X30 - 8MM 3-SLOT ANODISED BLACK

Price per meter

**Product code:** TS-3030-8-3-B

**Colour:** Black anodised

**Bar Length:** 5800 mm

[Read More](#)

**SKU:** T30.3030-3-8-B

**Price:** \$21.80 Ex GST per Meter

**Categories:** [30 Series](#), [T slot Aluminium Profiles](#), [T Slot profile and accessories](#)

**Tags:** [30 Series](#), [3030](#), [8mm Slot](#), [Aluminium Extrusion](#), [black anodized aluminium extrusion](#), [T-Slot](#)

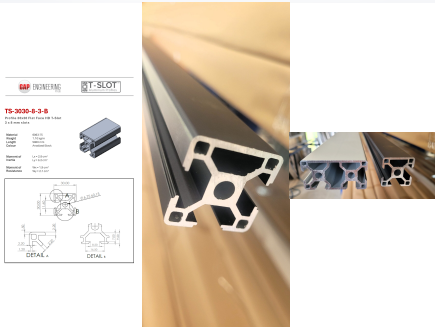
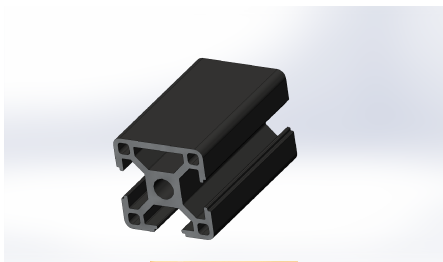



## PROFILE 30X30 - 8MM 3-SLOT ANODISED CLEAR

Price per meter

**Product code:** TS-3030-8-3

**Colour:** Natural anodized

**Bar Length:** 5800 mm

[Read More](#)

**SKU:** T30.3030.4.GAP-5

**Price:** \$20.80 Ex GST per Meter

**Categories:** [30 Series](#), [T slot Aluminium Profiles](#), [T Slot profile and accessories](#)

**Tags:** [30 Series](#), [3030](#), [8mm Slot](#), [Aluminium Extrusion](#), [T-Slot](#)



### TS-3030-8-3

Profile 30x30 Flat Face HD T-Slot  
3 x 8 mm slots

**Material:** 6063-T5  
**Weight:** 1.10 kg/m  
**Length:** 5800 mm  
**Colour:** Natural Anodized Silver

**Moment of Inertia:** Lx = 2.9 cm<sup>4</sup>  
Ly = 3.2 cm<sup>4</sup>

**Moment of Resistance:** Wx = 1.9 cm<sup>3</sup>  
Wy = 2.1 cm<sup>3</sup>

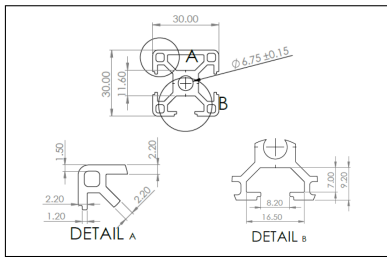
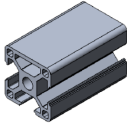

## PROFILE 30X30 - 8MM SLOT ANODISED BLACK

Price per meter

**Product code:** TS-3030-8-4-B

**Colour:** Black anodised

**Bar Length:** 5800 mm

[Read More](#)

**SKU:** T30.3030.4.GAP-4

**Price:** \$20.80 Ex GST per Meter

**Categories:** [30 Series](#), [T slot Aluminium Profiles](#), [T Slot profile and accessories](#)

**Tags:** [30 Series](#), [3030](#), [8mm Slot](#), [Aluminium Extrusion](#), [Mat Black](#), [T-Slot](#)



### TS-3030-8-4-B

Profile 30x30 HD T-Slot  
1 x 8 mm slot

**Material:** 6063-T5  
**Weight:** 0.87 kg/m  
**Length:** 5800 mm  
**Colour:** Anodized Black

**Moment of Inertia:** Lx = 2.9 cm<sup>4</sup>  
Ly = 3.2 cm<sup>4</sup>

**Moment of Resistance:** Wx = 1.9 cm<sup>3</sup>  
Wy = 2.1 cm<sup>3</sup>

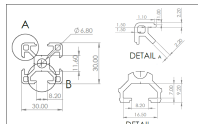
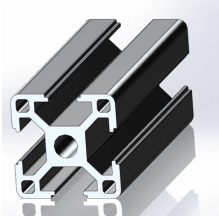



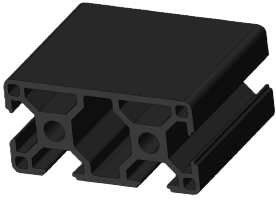

## PROFILE 30X60 - 8MM 4-SLOT CLOSED FACE ANODISED BLACK

Price per meter

**Product code:** TS-3060-8-4-B

**Colour:** Black anodised

**Bar Length:** 5800 mm

[Read More](#)

**SKU:** T30.3060.4.GAP-1-1

**Price:** \$39.35 Ex GST per Meter

**Categories:** [30 Series](#), [T slot Aluminium Profiles](#), [T Slot profile and accessories](#)

**Tags:** [30 Series](#), [3060](#), [8mm Slot](#), [Aluminium Extrusion](#), [T-Slot](#)

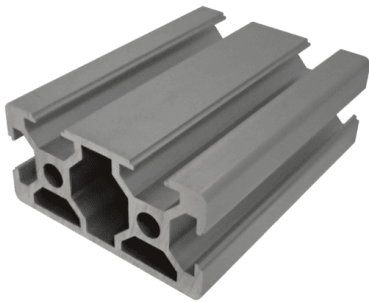
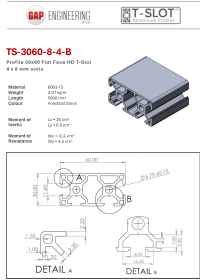

## PROFILE 30X60 - 8MM 4-SLOT CLOSED FACE ANODISED CLEAR

Price per meter

**Product code:** TS-3060-8-4

**Colour:** Natural anodised

**Bar Length:** 5800 mm

[Read More](#)

**SKU:** T30.3060.4.GAP-1

**Price:** \$38.75 Ex GST per Meter

**Categories:** [30 Series](#), [T slot Aluminium Profiles](#), [T Slot profile and accessories](#)

**Tags:** [30 Series](#), [3060](#), [8mm Slot](#), [Aluminium Extrusion](#), [T-Slot](#)

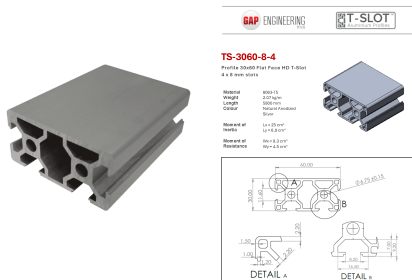

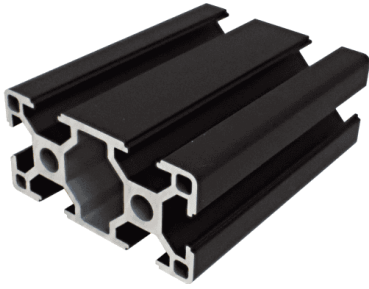

## PROFILE 30X60 - 8MM SLOT ANODISED BLACK

Price per meter

**Product code:** TS-3060-8-6-B

**Colour:** Black anodised

**Bar Length:** 5800 mm

[Read More](#)

**SKU:** T30.3060.6.GAP-2

**Price:** \$39.51 Ex GST per Meter

**Categories:** [30 Series](#), [T slot Aluminium Profiles](#), [T Slot profile and accessories](#)

**Tags:** [30 Series](#), [3060](#), [8mm Slot](#), [Aluminium Extrusion](#), [Mat Black](#), [T-Slot](#)

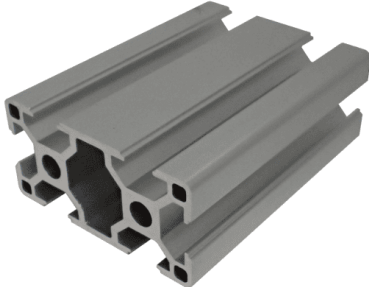
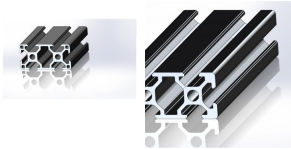
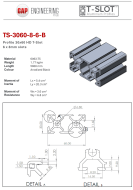

## PROFILE 30X60 - 8MM SLOT ANODISED CLEAR

Price per meter

**Product code:** TS-3060-8-6

**Colour:** Natural anodized

**Bar Length:** 5800 mm

[Read More](#)

**SKU:** T30.3060.6.GAP

**Price:** \$36.80 Ex GST per Meter

**Categories:** [30 Series](#), [T slot Aluminium Profiles](#), [T Slot profile and accessories](#)

**Tags:** [30 Series](#), [3060](#), [8mm Slot](#), [Aluminium Extrusion](#), [T-Slot](#)

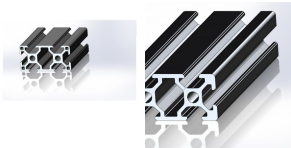
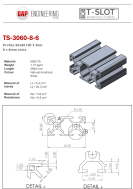



## PROFILE 40X120 - 8MM SLOT ANODISED CLEAR

Price per meter

**Product code:** TS-40120-8-8

**Colour:** Natural anodized

**Bar Length:** 5800 mm

[Read More](#)

**SKU:** N/A

**Price:** \$87.29 Ex GST per Meter

**Categories:** [40 Series](#), [T slot Aluminium Profiles](#), [T Slot profile and accessories](#)

**Tags:** [40 Series](#), [40120](#), [8mm Slot](#), [Aluminium Extrusion](#), [Special Order](#), [T-Slot](#)

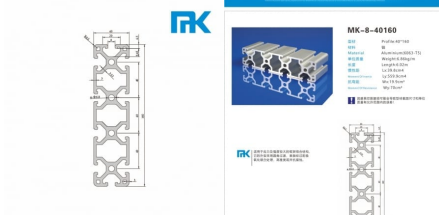

## PROFILE 40X160 - 8MM SLOT ANODISED BLACK

Price per meter

**Product code:** TS-40160-8-10-B

**Colour:** Black anodised

**Bar Length:** 5800 mm

[Read More](#)

**SKU:** N/A

**Price:** \$139.82 Ex GST per Meter

**Categories:** [40 Series](#), [T slot Aluminium Profiles](#), [T Slot profile and accessories](#)

**Tags:** [40 Series](#), [40160](#), [8mm Slot](#), [Aluminium Extrusion](#), [Mat Black](#), [Special Order](#), [T-Slot](#)

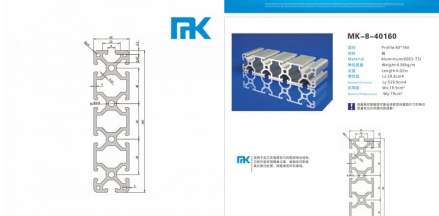



## PROFILE 40X40 - 8 MM 2-SLOT HALF CLOSED ANODISED CLEAR

Price per meter

**Product code:** TS-4040-8-2

**Colour:** Natural anodized

**Bar Length:** 5800 mm

[Read More](#)

**SKU:** N/A

**Price:** \$36.43 Ex GST per Meter

**Categories:** [40 Series](#), [T slot Aluminium Profiles](#), [T Slot profile and accessories](#)

**Tags:** [40 Series](#), [4040](#), [8mm Slot](#), [Aluminium Extrusion](#), [Special Order](#), [T-Slot](#)

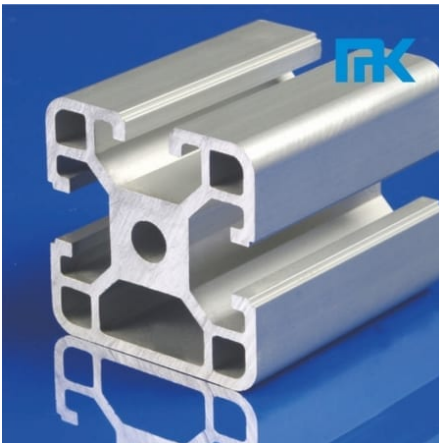
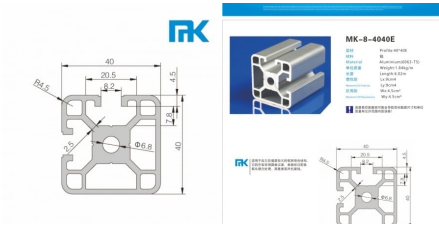

## PROFILE 40X40 - 8MM 3-SLOT CLOSED FACE ANODISED CLEAR

Price per meter

**Product code:** TS-4040-8-3

**Colour:** Natural anodized

**Bar Length:** 5800 mm

[Read More](#)

**SKU:** N/A

**Price:** \$36.04 Ex GST per Meter

**Categories:** [40 Series](#), [T slot Aluminium Profiles](#), [T Slot profile and accessories](#)

**Tags:** [40 Series](#), [4040](#), [8mm Slot](#), [Aluminium Extrusion](#), [Special Order](#), [T-Slot](#)





## PROFILE 40X40 - 8MM SLOT ANODISED BLACK

Price per meter

**Product code:** TS-B-4040-8-4-B

**Colour:** Anodised Black

**Bar Length:** 5800 mm

[Read More](#)

**SKU:** N/A

**Price:** \$39.50 Ex GST per Meter

**Categories:** [40 Series](#), [T slot Aluminium Profiles](#), [T Slot profile and accessories](#)

**Tags:** [40 Series](#), [4040](#), [Aluminium Extrusion](#), [T-Slot](#)

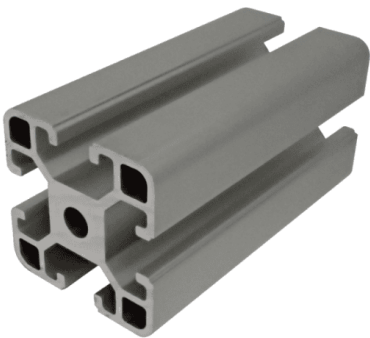

## PROFILE 40X40 - 8MM SLOT ANODISED CLEAR

Price per meter

**Product code:** TS-B-4040-8-4

**Colour:** Natural anodized

**Bar Length:** 5800 mm

[Read More](#)

**SKU:** N/A

**Price:** \$33.00 Ex GST per Meter

**Categories:** [40 Series](#), [T slot Aluminium Profiles](#), [T Slot profile and accessories](#)

**Tags:** [40 Series](#), [4040](#), [Aluminium Extrusion](#), [NEW](#), [T-Slot](#)



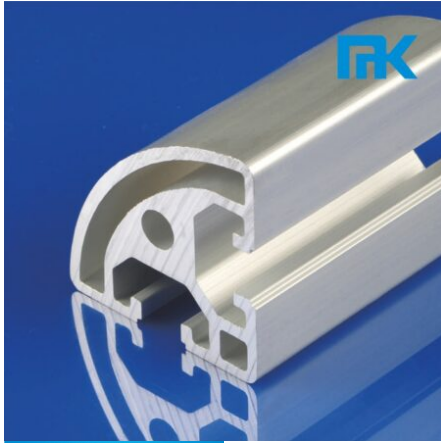

## PROFILE 40X40 R - 8MM SLOT ANODISED CLEAR

Price per meter

**Product code:** TS-R-4040-8-2

**Colour:** Natural anodized

**Bar Length:** 5800 mm

[Read More](#)

**SKU:** N/A

**Price:** \$35.45 Ex GST per Meter

**Categories:** [40 Series](#), [T slot Aluminium Profiles](#), [T Slot profile and accessories](#)

**Tags:** [40 Series](#), [4040](#), [8mm Slot](#), [Aluminium Extrusion](#), [Round Profile](#), [T-Slot](#)



## PROFILE 40X80 - 8MM SLOT ANODISED BLACK

Price per meter

**Product code:** TS-4080-8-6-B

**Colour:** Black anodised

**Bar Length:** 5800 mm

[Read More](#)

**SKU:** N/A

**Price:** \$60.55 Ex GST

**Categories:** [40 Series](#), [T Slot profile and accessories](#)

**Tags:** [40 Series](#), [4080](#), [8mm Slot](#), [Aluminium Extrusion](#), [Mat Black](#), [T-Slot](#)

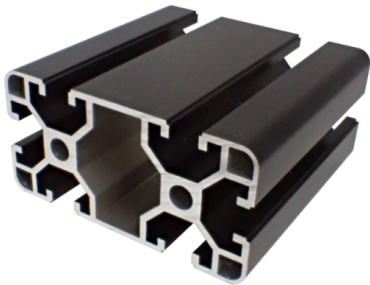

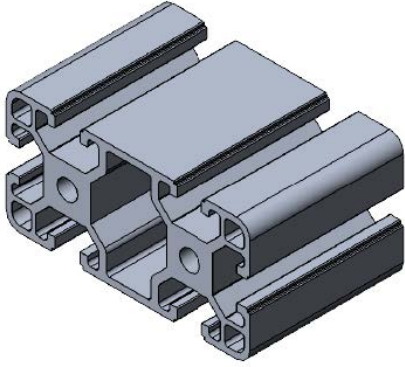

## PROFILE 40X80 - 8MM SLOT ANODISED CLEAR

Price per meter

**Product code:** TS-4080-8-6

**Colour:** Natural anodized

**Bar Length:** 5800 mm

[Read More](#)

**SKU:** N/A

**Price:** \$57.22 Ex GST per Meter

**Categories:** [40 Series](#), [T slot Aluminium Profiles](#), [T Slot profile and accessories](#)

**Tags:** [40 Series](#), [4080](#), [8mm Slot](#), [Aluminium Extrusion](#), [T-Slot](#)

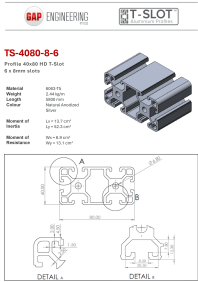

## PROFILE 45X45 10MM SLOT ANODISED BLACK

Price per meter

**Product Code :** TS-4545-10-4-B

**Colour :** Anodised Black

**Bar Length :** 5800 mm

[Read More](#)

**SKU:** ALS.084.101.012-1

**Price:** \$42.85 Ex GST per Meter

**Categories:** [45 Series](#), [T slot Aluminium Profiles](#), [T Slot profile and accessories](#)

**Tags:** [10mm Slot](#), [45 Series](#), [4545](#), [Aluminium Extrusion](#), [T-Slot](#)

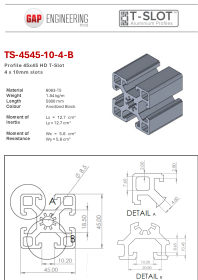

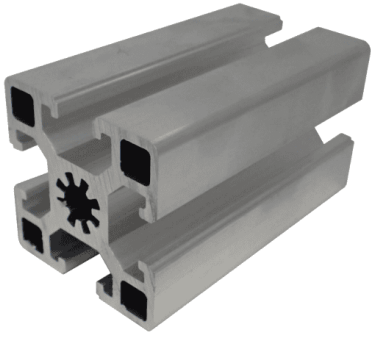

## PROFILE 45X45 10MM SLOT ANODISED CLEAR

Price per meter

**Product Code :** TS-4545-10-4

**Colour :** Natural Anodised

**Bar Length :** 5800 mm

[Read More](#)

**SKU:** ALS.084.101.012

**Price:** \$41.27 Ex GST per Meter

**Categories:** [45 Series](#), [T slot Aluminium Profiles](#), [T Slot profile and accessories](#)

**Tags:** [10mm Slot](#), [45 Series](#), [4545](#), [Aluminium Extrusion](#), [T-Slot](#)

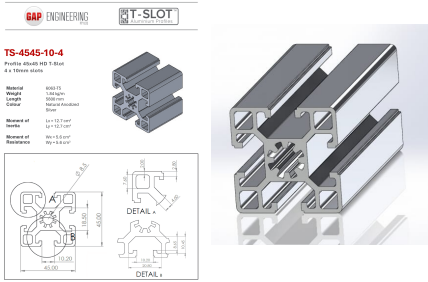

GAP ENGINEERING

T-SLOT

TS-4545-10-4

Profile 45x45 HD 10 slot  
4 x 10mm slots

Material: 6063-T5  
Weight: 1.02kg/m  
Length: 5800mm  
Colour: Natural Anodised  
Finish: Clear

Weight of stock: 57.12kg  
L x W x H: 45 x 45 x 45

Weight of stock: 57.12kg  
L x W x H: 45 x 45 x 45

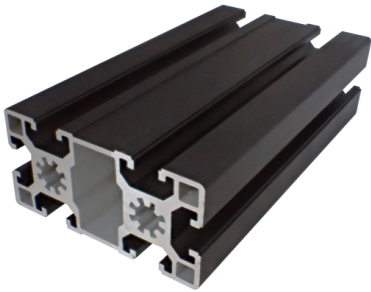
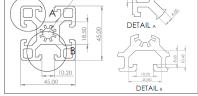

## PROFILE 45X90 10MM SLOT ANODISED BLACK

Price per meter

**Product Code:** TS-4590-10-6-B

**Colour:** Anodised Black

**Bar Length:** 5800 mm

[Read More](#)

**SKU:** N/A

**Price:** \$75.60 Ex GST per Meter

**Categories:** [45 Series](#), [T slot Aluminium Profiles](#), [T Slot profile and accessories](#)

**Tags:** [10mm Slot](#), [45 Series](#), [4590](#), [Aluminium Extrusion](#), [T-Rax Cargo System](#), [T-Slot](#)

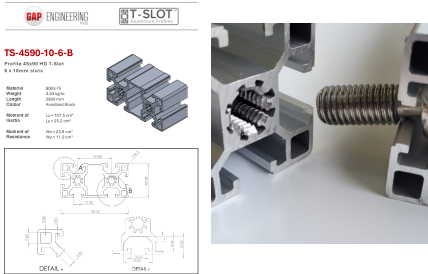

GAP ENGINEERING

T-SLOT

TS-4590-10-6-B

Profile 45x90 HD 10 slot  
6 x 10mm slots

Material: 6063-T5  
Weight: 1.02kg/m  
Length: 5800mm  
Colour: Anodised Black  
Finish: Clear

Weight of stock: 57.12kg  
L x W x H: 45 x 90 x 45

Weight of stock: 57.12kg  
L x W x H: 45 x 90 x 45

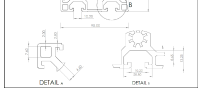

## PROFILE 45X90 10MM SLOT ANODISED CLEAR

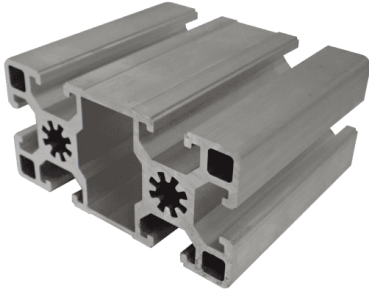

Price per meter

**Product Code:** TS-4590-10-6

**Colour:** Natural anodised

**Bar Length:** 5800 mm

[Read More](#)

**SKU:** N/A

**Price:** \$72.60 Ex GST per Meter

**Categories:** [45 Series](#), [T slot Aluminium Profiles](#), [T Slot profile and accessories](#)

**Tags:** [10mm Slot](#), [45 Series](#), [4590](#), [Aluminium Extrusion](#), [T-Rax Cargo System](#), [T-Slot](#)

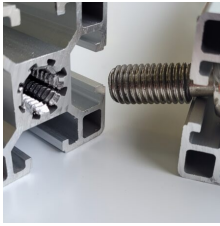
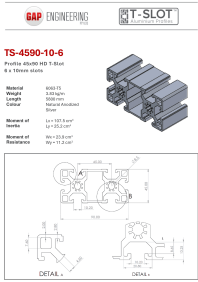

## PROFILE 80X160 - 8MM SLOT ANODISED CLEAR

Price per meter

**Product code:** TS-80160-8-12

**Colour:** Natural anodized

**Bar Length:** 5800 mm

[Read More](#)

**SKU:** N/A

**Price:** \$178.20 Ex GST per Meter

**Categories:** [40 Series](#), [T slot Aluminium Profiles](#), [T Slot profile and accessories](#)

**Tags:** [40 Series](#), [80160](#), [8mm Slot](#), [Aluminium Extrusion](#), [Special Order](#), [T-Slot](#)

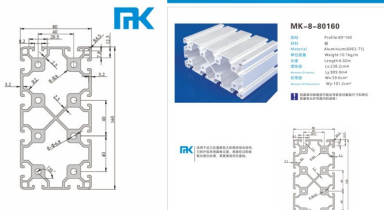



# INDEX

## 1

16x40 T-Slot Aluminium Profile | 8mm & 6mm Slots | Black | GAP Engineering 3

16x40 T-Slot Aluminium Profile | 8mm & 6mm Slots | GAP Engineering 3

## C

Cutting service 4

## D

Drilling and tapping service 4

## P

Profile 20x20 - 6mm slot Anodised Black 5

Profile 20x20 - 6mm slot Anodised Clear 5

Profile 20x40 - 6mm slot Anodised Black 6

Profile 20x40 - 6mm slot Anodised Clear 6

Profile 20x60 - 6mm slot Anodised Clear 7

Profile 20x80 - 6mm slot Anodised Clear 7

Profile 30x120 - 8mm slot Anodised Clear 8

Profile 30x30 - 8mm 3-slot Anodised Black 8

Profile 30x30 - 8mm 3-slot Anodised Clear 9

Profile 30x30 - 8mm slot Anodised Black 9

Profile 30x30 - 8mm slot Anodised Clear 10

Profile 30x30R - 8mm slot Anodised Clear 10

Profile 30x60 - 8mm 4-slot closed face Anodised Black 11

Profile 30x60 - 8mm 4-slot closed face Anodised Clear 11

Profile 30x60 - 8mm slot Anodised Black 12

Profile 30x60 - 8mm slot Anodised Clear 12

Profile 40x120 - 8mm slot Anodised Clear 13

Profile 40x160 - 8mm slot Anodised Black 13

Profile 40x40 - 8 mm 2-slot half closed Anodised Clear 14

Profile 40x40 - 8mm 3-slot closed face Anodised Clear 14

Profile 40x40 - 8mm slot Anodised Black 15

Profile 40x40 - 8mm slot Anodised Clear 15

Profile 40x40 R - 8mm slot Anodised Clear 16

Profile 40x80 - 8mm slot Anodised Black 16

Profile 40x80 - 8mm slot Anodised Clear 17

Profile 45x45 10mm slot Anodised Black 17

Profile 45x45 10mm slot Anodised Clear 18

Profile 45x90 10mm slot Anodised Black 18

Profile 45x90 10mm slot Anodised Clear 19

Profile 80x160 - 8mm slot Anodised Clear 19