

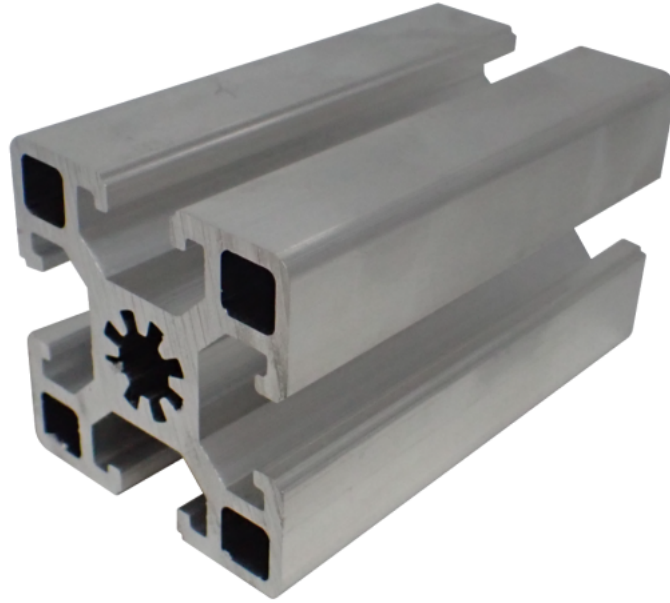

PRODUCT CATALOGUE

TABLE OF CONTENTS

45 Series	2
-----------------	---



45 SERIES

45 SERIES T SLOT EXTRUDED ALUMINIUM PROFILES

To order cut lengths of a profile please fill in the form in the [cutting service page](#).

Our profile come in 5.8-meter lengths

All prices indicated are **per meter**

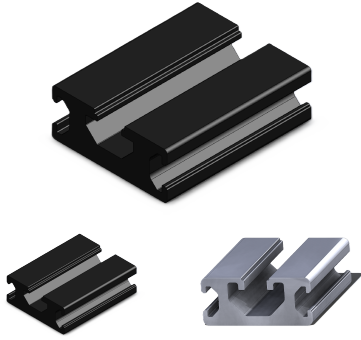

16X40 T-SLOT ALUMINIUM PROFILE | 8MM & 6MM SLOTS | BLACK | GAP ENGINEERING

Price per meter

Product code: TS-1640-6-8-3-B

Colour: Black anodized

Bar Length: 5800 mm

[Read More](#)

SKU: N/A

Price: \$28.24 Ex GST

Categories: [40 Series](#), [T Slot profile and accessories](#)

Tags: [1640](#), [40 Series](#), [8mm Slot](#), [Aluminium Extrusion](#), [NEW](#), [Roll in Spring Nut](#), [T-Slot](#)

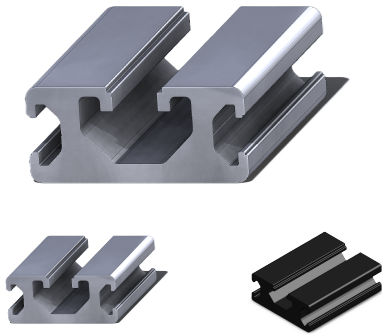

16X40 T-SLOT ALUMINIUM PROFILE | 8MM & 6MM SLOTS | GAP ENGINEERING

Price per meter

Product code: TS-1640-6-8-3

Colour: Silver anodized

Bar Length: 5800 mm

[Read More](#)

SKU: N/A

Price: \$21.54 Ex GST

Categories: [40 Series](#), [T Slot profile and accessories](#)

Tags: [1640](#), [40 Series](#), [8mm Slot](#), [Aluminium Extrusion](#), [NEW](#), [Roll in Spring Nut](#), [T-Slot](#)



CUTTING SERVICE

Cutting accurately and neatly is crucial for getting a great result when using T Slot Extrusions.

Complete the cutting list below and we will prepare your material for you.

Click the + at the end of the line to add a new line

Transport costs are reduced according to the length of the goods.

[Read More](#)

SKU: N/A

Price: \$3.25 Ex GST

Categories: [20 Series](#), [30 Series](#), [40 Series](#), [45 Series](#), [Services](#)



DRILLING AND TAPPING SERVICE

Drill and tapping in the correct positions for easy assembly of your project.

[Read More](#)

SKU: N/A

Price: \$4.25 Ex GST

Categories: [20 Series](#), [30 Series](#), [40 Series](#), [45 Series](#), [Services](#), [T Slot profile and accessories](#)

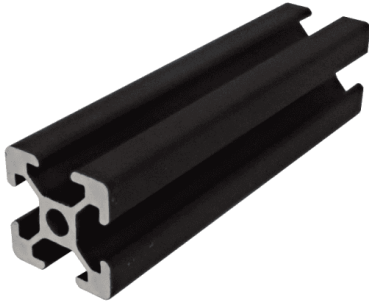

PROFILE 20X20 - 6MM SLOT ANODISED BLACK

Price per meter

Product code: TS-2020-6-4-B

Colour: Black anodised

Bar length: 5800mm

[Read More](#)

SKU: N/A

Price: \$16.50 Ex GST per Meter

Categories: [20 Series](#), [T slot Aluminium Profiles](#), [T Slot profile and accessories](#)

Tags: [20 Series](#), [2020](#), [6mm Slot](#), [Aluminium Extrusion](#), [Mat Black](#), [T-Slot](#)

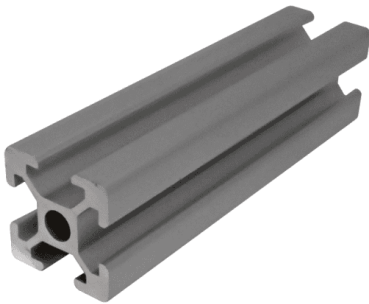
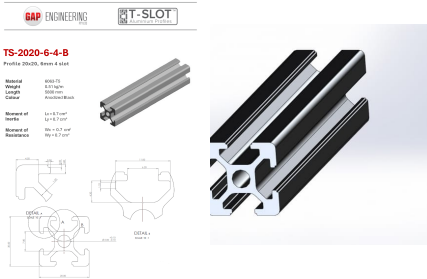

PROFILE 20X20 - 6MM SLOT ANODISED CLEAR

Price per meter

Product code: TS-2020-6-4

Colour: Natural anodised

Bar length: 5800mm

[Read More](#)

SKU: N/A

Price: \$13.20 Ex GST per Meter

Categories: [20 Series](#), [T slot Aluminium Profiles](#), [T Slot profile and accessories](#)

Tags: [20 Series](#), [2020](#), [6mm Slot](#), [Aluminium Extrusion](#), [T-Slot](#)

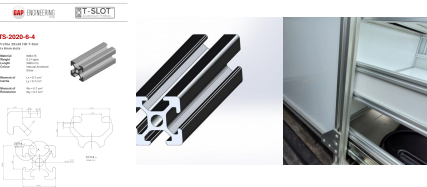

PROFILE 20X40 - 6MM SLOT ANODISED BLACK

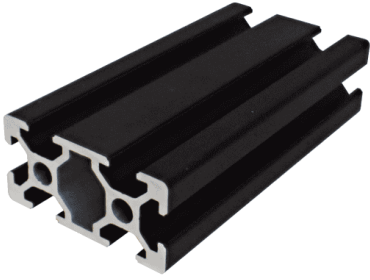

Price per meter

Product code: TS-2040-6-6-B

Colour: Black anodised

Bar length: 5800mm

[Read More](#)

SKU: N/A

Price: \$23.20 Ex GST per Meter

Categories: [20 Series](#), [T slot Aluminium Profiles](#), [T Slot profile and accessories](#)

Tags: [20 Series](#), [2040](#), [6mm Slot](#), [Aluminium Extrusion](#), [Mat Black](#), [T-Slot](#)

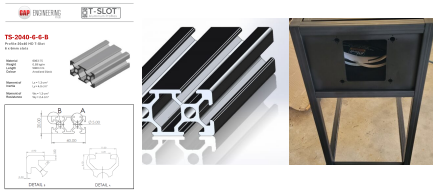

PROFILE 20X40 - 6MM SLOT ANODISED CLEAR

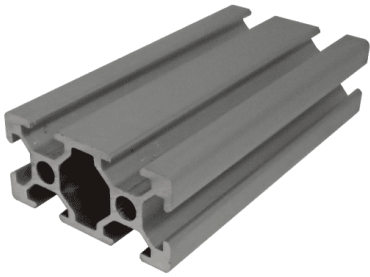

Price per meter

Product code: TS-2040-6-6

Colour: Natural anodized

Bar Length: 5800 mm

[Read More](#)

SKU: N/A

Price: \$20.40 Ex GST per Meter

Categories: [20 Series](#), [T slot Aluminium Profiles](#), [T Slot profile and accessories](#)

Tags: [20 Series](#), [2040](#), [6mm Slot](#), [Aluminium Extrusion](#), [T-Slot](#)

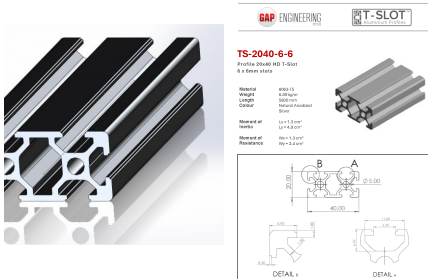

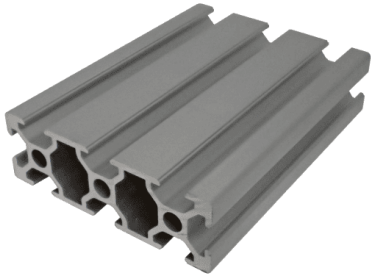

PROFILE 20X60 - 6MM SLOT ANODISED CLEAR

Price per meter

Product code: TS-2060-6-8

Colour: Natural anodized

Bar Length: 5800 mm

[Read More](#)

SKU: N/A

Price: \$24.76 Ex GST per Meter

Categories: [20 Series](#), [T slot Aluminium Profiles](#), [T Slot profile and accessories](#)

Tags: [20 Series](#), [2060](#), [6mm Slot](#), [Aluminium Extrusion](#), [Special Order](#), [T-Slot](#)

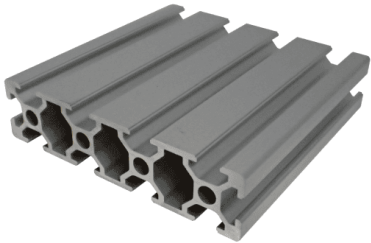

PROFILE 20X80 - 6MM SLOT ANODISED CLEAR

Price per meter

Product code: TS-2080-6-10

Colour: Natural anodized

Bar Length: 5800 mm

[Read More](#)

SKU: N/A

Price: \$30.70 Ex GST per Meter

Categories: [20 Series](#), [Accessories](#), [T slot Aluminium Profiles](#)

Tags: [20 Series](#), [2080](#), [6mm Slot](#), [Aluminium Extrusion](#), [Special Order](#), [T-Slot](#)

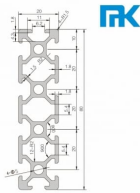

PROFILE 30X120 - 8MM SLOT ANODISED CLEAR

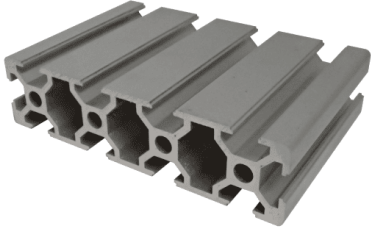

Price per meter

Product code: TS-30120-8-10

Colour: Natural anodized

Bar Length: 5800 mm

[Read More](#)

SKU: T30.3030.4.GAP-1

Price: \$69.30 Ex GST per Meter

Categories: [30 Series](#), [T slot Aluminium Profiles](#), [T Slot profile and accessories](#)

Tags: [30 Series](#), [30120](#), [8mm Slot](#), [Aluminium Extrusion](#), [Special Order](#), [T-Slot](#)

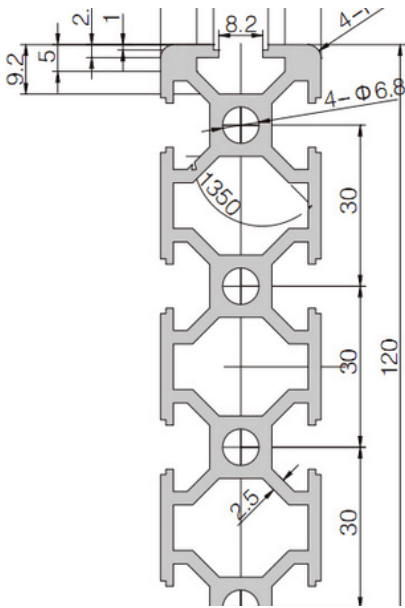

PROFILE 30X30 - 8MM 3-SLOT ANODISED BLACK

Price per meter

Product code: TS-3030-8-3-B

Colour: Black anodised

Bar Length: 5800 mm

[Read More](#)

SKU: T30.3030-3-8-B

Price: \$21.80 Ex GST per Meter

Categories: [30 Series](#), [T slot Aluminium Profiles](#), [T Slot profile and accessories](#)

Tags: [30 Series](#), [3030](#), [8mm Slot](#), [Aluminium Extrusion](#), [black anodized aluminium extrusion](#), [T-Slot](#)

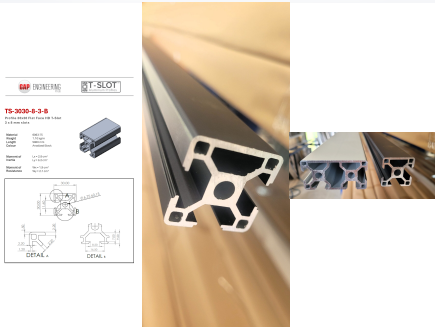
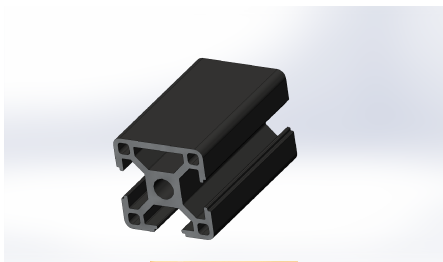



PROFILE 30X30 - 8MM 3-SLOT ANODISED CLEAR

Price per meter

Product code: TS-3030-8-3

Colour: Natural anodized

Bar Length: 5800 mm

[Read More](#)

SKU: T30.3030.4.GAP-5

Price: \$20.80 Ex GST per Meter

Categories: [30 Series](#), [T slot Aluminium Profiles](#), [T Slot profile and accessories](#)

Tags: [30 Series](#), [3030](#), [8mm Slot](#), [Aluminium Extrusion](#), [T-Slot](#)



TS-3030-8-3

Profile 30x30 Flat Face HD T-Slot
3 x 8 mm slots

Material: 6063-T5
Weight: 1.10 kg/m
Length: 5800 mm
Colour: Natural Anodized Silver

Moment of Inertia: Lx = 2.9 cm⁴
Ly = 3.2 cm⁴

Moment of Resistance: Wx = 1.9 cm³
Wy = 2.1 cm³

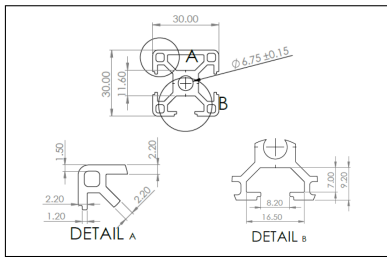
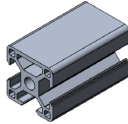

PROFILE 30X30 - 8MM SLOT ANODISED BLACK

Price per meter

Product code: TS-3030-8-4-B

Colour: Black anodised

Bar Length: 5800 mm

[Read More](#)

SKU: T30.3030.4.GAP-4

Price: \$20.80 Ex GST per Meter

Categories: [30 Series](#), [T slot Aluminium Profiles](#), [T Slot profile and accessories](#)

Tags: [30 Series](#), [3030](#), [8mm Slot](#), [Aluminium Extrusion](#), [Mat Black](#), [T-Slot](#)



TS-3030-8-4-B

Profile 30x30 HD T-Slot
4 slots

Material: 6063-T5
Weight: 1.10 kg/m
Length: 5800 mm
Colour: Anodized Black

Moment of Inertia: Lx = 2.9 cm⁴
Ly = 3.2 cm⁴

Moment of Resistance: Wx = 1.9 cm³
Wy = 2.1 cm³

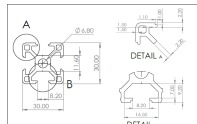
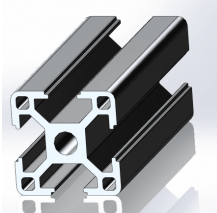



PROFILE 30X30 - 8MM SLOT ANODISED CLEAR

Price per meter

Product code: TS-3030-8-4

Colour: Natural anodized

Bar Length: 5800 mm

[Read More](#)

SKU: T30.3030.4.GAP

Price: \$17.85 Ex GST per Meter

Categories: [30 Series](#), [T slot Aluminium Profiles](#), [T Slot profile and accessories](#)

Tags: [30 Series](#), [3030](#), [8mm Slot](#), [Aluminium Extrusion](#), [T-Slot](#)

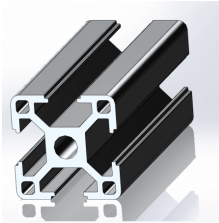
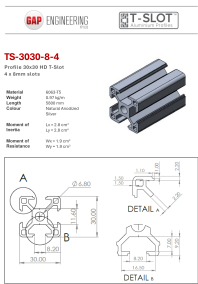

PROFILE 30X30R - 8MM SLOT ANODISED CLEAR

Price per meter

Product code: TS-R-3030-8-2

Colour: Natural anodized

Bar Length: 5800 mm

[Read More](#)

SKU: T30.3030.4.GAP-2

Price: \$17.55 Ex GST per Meter

Categories: [30 Series](#), [T slot Aluminium Profiles](#), [T Slot profile and accessories](#)

Tags: [30 Series](#), [3030](#), [8mm Slot](#), [Aluminium Extrusion](#), [Round Profile](#), [T-Slot](#)

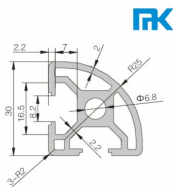

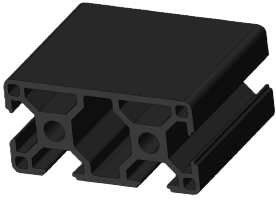

PROFILE 30X60 - 8MM 4-SLOT CLOSED FACE ANODISED BLACK

Price per meter

Product code: TS-3060-8-4-B

Colour: Black anodised

Bar Length: 5800 mm

[Read More](#)

SKU: T30.3060.4.GAP-1-1

Price: \$39.35 Ex GST per Meter

Categories: [30 Series](#), [T slot Aluminium Profiles](#), [T Slot profile and accessories](#)

Tags: [30 Series](#), [3060](#), [8mm Slot](#), [Aluminium Extrusion](#), [T-Slot](#)

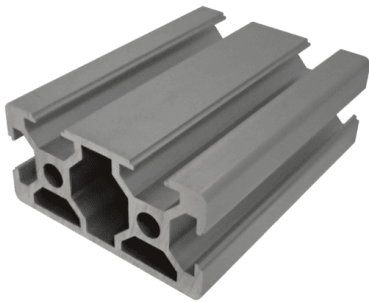
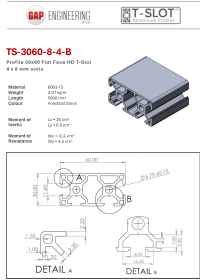

PROFILE 30X60 - 8MM 4-SLOT CLOSED FACE ANODISED CLEAR

Price per meter

Product code: TS-3060-8-4

Colour: Natural anodised

Bar Length: 5800 mm

[Read More](#)

SKU: T30.3060.4.GAP-1

Price: \$38.75 Ex GST per Meter

Categories: [30 Series](#), [T slot Aluminium Profiles](#), [T Slot profile and accessories](#)

Tags: [30 Series](#), [3060](#), [8mm Slot](#), [Aluminium Extrusion](#), [T-Slot](#)

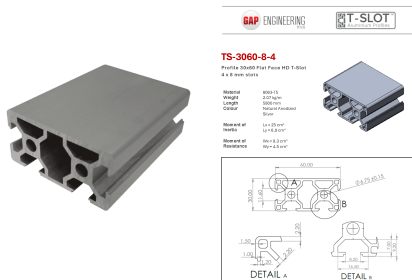

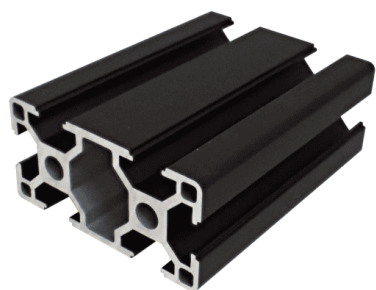

PROFILE 30X60 - 8MM SLOT ANODISED BLACK

Price per meter

Product code: TS-3060-8-6-B

Colour: Black anodised

Bar Length: 5800 mm

[Read More](#)

SKU: T30.3060.6.GAP-2

Price: \$39.51 Ex GST per Meter

Categories: [30 Series](#), [T slot Aluminium Profiles](#), [T Slot profile and accessories](#)

Tags: [30 Series](#), [3060](#), [8mm Slot](#), [Aluminium Extrusion](#), [Mat Black](#), [T-Slot](#)

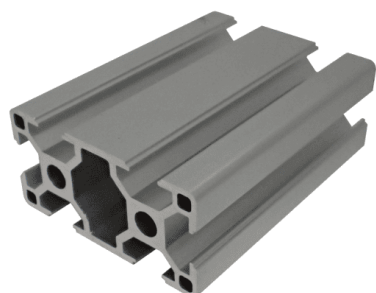
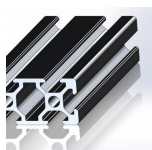
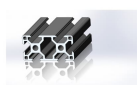
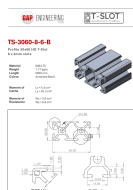

PROFILE 30X60 - 8MM SLOT ANODISED CLEAR

Price per meter

Product code: TS-3060-8-6

Colour: Natural anodized

Bar Length: 5800 mm

[Read More](#)

SKU: T30.3060.6.GAP

Price: \$36.80 Ex GST per Meter

Categories: [30 Series](#), [T slot Aluminium Profiles](#), [T Slot profile and accessories](#)

Tags: [30 Series](#), [3060](#), [8mm Slot](#), [Aluminium Extrusion](#), [T-Slot](#)

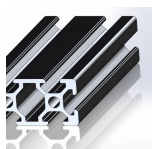
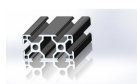



PROFILE 40X120 - 8MM SLOT ANODISED CLEAR

Price per meter

Product code: TS-40120-8-8

Colour: Natural anodized

Bar Length: 5800 mm

[Read More](#)

SKU: N/A

Price: \$87.29 Ex GST per Meter

Categories: [40 Series](#), [T slot Aluminium Profiles](#), [T Slot profile and accessories](#)

Tags: [40 Series](#), [40120](#), [8mm Slot](#), [Aluminium Extrusion](#), [Special Order](#), [T-Slot](#)

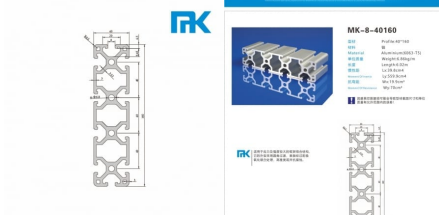

PROFILE 40X160 - 8MM SLOT ANODISED BLACK

Price per meter

Product code: TS-40160-8-10-B

Colour: Black anodised

Bar Length: 5800 mm

[Read More](#)

SKU: N/A

Price: \$139.82 Ex GST per Meter

Categories: [40 Series](#), [T slot Aluminium Profiles](#), [T Slot profile and accessories](#)

Tags: [40 Series](#), [40160](#), [8mm Slot](#), [Aluminium Extrusion](#), [Mat Black](#), [Special Order](#), [T-Slot](#)

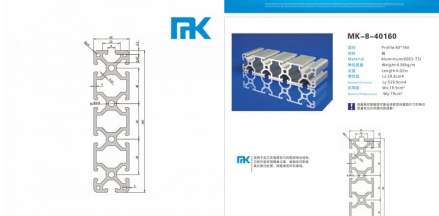



PROFILE 40X40 - 8 MM 2-SLOT HALF CLOSED ANODISED CLEAR

Price per meter

Product code: TS-4040-8-2

Colour: Natural anodized

Bar Length: 5800 mm

[Read More](#)

SKU: N/A

Price: \$36.43 Ex GST per Meter

Categories: [40 Series](#), [T slot Aluminium Profiles](#), [T Slot profile and accessories](#)

Tags: [40 Series](#), [4040](#), [8mm Slot](#), [Aluminium Extrusion](#), [Special Order](#), [T-Slot](#)

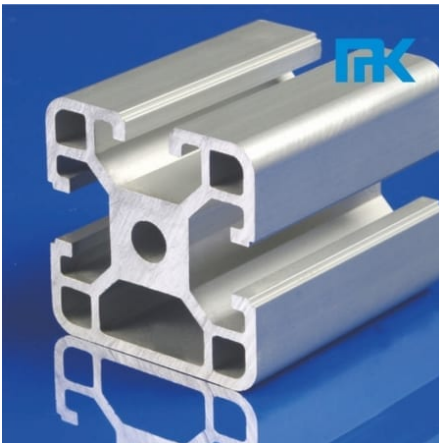
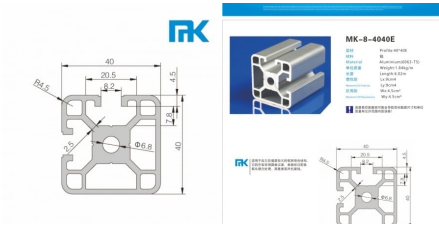

PROFILE 40X40 - 8MM 3-SLOT CLOSED FACE ANODISED CLEAR

Price per meter

Product code: TS-4040-8-3

Colour: Natural anodized

Bar Length: 5800 mm

[Read More](#)

SKU: N/A

Price: \$36.04 Ex GST per Meter

Categories: [40 Series](#), [T slot Aluminium Profiles](#), [T Slot profile and accessories](#)

Tags: [40 Series](#), [4040](#), [8mm Slot](#), [Aluminium Extrusion](#), [Special Order](#), [T-Slot](#)





PROFILE 40X40 - 8MM SLOT ANODISED BLACK

Price per meter

Product code: TS-B-4040-8-4-B

Colour: Anodised Black

Bar Length: 5800 mm

[Read More](#)

SKU: N/A

Price: \$39.50 Ex GST per Meter

Categories: [40 Series](#), [T slot Aluminium Profiles](#), [T Slot profile and accessories](#)

Tags: [40 Series](#), [4040](#), [Aluminium Extrusion](#), [T-Slot](#)

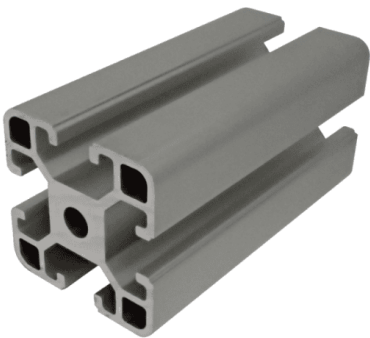

PROFILE 40X40 - 8MM SLOT ANODISED CLEAR

Price per meter

Product code: TS-B-4040-8-4

Colour: Natural anodized

Bar Length: 5800 mm

[Read More](#)

SKU: N/A

Price: \$33.00 Ex GST per Meter

Categories: [40 Series](#), [T slot Aluminium Profiles](#), [T Slot profile and accessories](#)

Tags: [40 Series](#), [4040](#), [Aluminium Extrusion](#), [NEW](#), [T-Slot](#)



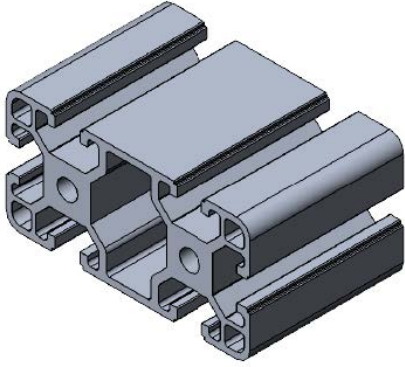

PROFILE 40X80 - 8MM SLOT ANODISED CLEAR

Price per meter

Product code: TS-4080-8-6

Colour: Natural anodized

Bar Length: 5800 mm

[Read More](#)

SKU: N/A

Price: \$57.22 Ex GST per Meter

Categories: [40 Series](#), [T slot Aluminium Profiles](#), [T Slot profile and accessories](#)

Tags: [40 Series](#), [4080](#), [8mm Slot](#), [Aluminium Extrusion](#), [T-Slot](#)

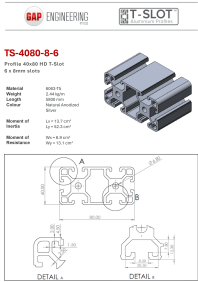

PROFILE 45X45 10MM SLOT ANODISED BLACK

Price per meter

Product Code : TS-4545-10-4-B

Colour : Anodised Black

Bar Length : 5800 mm

[Read More](#)

SKU: ALS.084.101.012-1

Price: \$42.85 Ex GST per Meter

Categories: [45 Series](#), [T slot Aluminium Profiles](#), [T Slot profile and accessories](#)

Tags: [10mm Slot](#), [45 Series](#), [4545](#), [Aluminium Extrusion](#), [T-Slot](#)

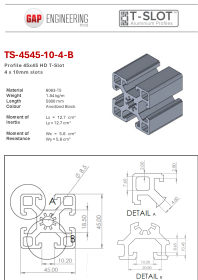

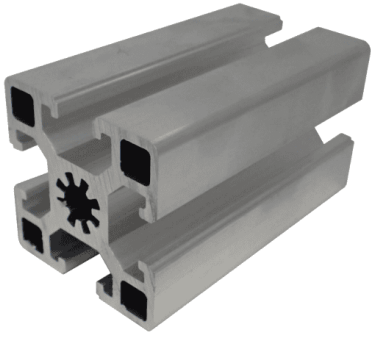

PROFILE 45X45 10MM SLOT ANODISED CLEAR

Price per meter

Product Code : TS-4545-10-4

Colour : Natural Anodised

Bar Length : 5800 mm

[Read More](#)

SKU: ALS.084.101.012

Price: \$41.27 Ex GST per Meter

Categories: [45 Series](#), [T slot Aluminium Profiles](#), [T Slot profile and accessories](#)

Tags: [10mm Slot](#), [45 Series](#), [4545](#), [Aluminium Extrusion](#), [T-Slot](#)

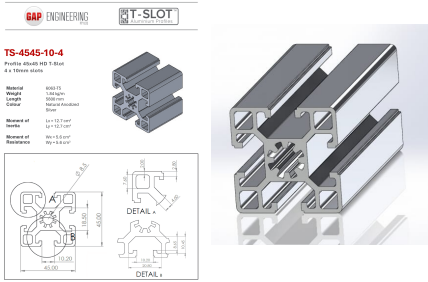

GAP ENGINEERING

T-SLOT

TS-4545-10-4

Profile 45x45x10 10mm slot

4 x 10mm slots

Material

Weight

Length

Colour

Weight of

Material

Weight of

Material

Weight of

Material

Weight of

Material

Weight of

Material

Weight of

Material

Weight of

Material

Weight of

Material

Weight of

Material

Weight of

Material

Weight of

Material

Weight of

Material

Weight of

Material

Weight of

Material

Weight of

Material

Weight of

Material

Weight of

Material

Weight of

Material

Weight of

Material

Weight of

Material

Weight of

Material

Weight of

Material

Weight of

Material

Weight of

Material

Weight of

Material

Weight of

Material

Weight of

Material

Weight of

Material

Weight of

Material

Weight of

Material

Weight of

Material

Weight of

Material

Weight of

Material

Weight of

Material

Weight of

Material

Weight of

Material

Weight of

Material

Weight of

Material

Weight of

Material

Weight of

Material

Weight of

Material

Weight of

Material

Weight of

Material

Weight of

Material

Weight of

Material

PROFILE 45X90 10MM SLOT ANODISED BLACK

Price per meter

Product Code: TS-4590-10-6-B

Colour: Anodised Black

Bar Length: 5800 mm

[Read More](#)

SKU: N/A

Price: \$75.60 Ex GST per Meter

Categories: [45 Series](#), [T slot Aluminium Profiles](#), [T Slot profile and accessories](#)

Tags: [10mm Slot](#), [45 Series](#), [4590](#), [Aluminium Extrusion](#), [T-Rax Cargo System](#), [T-Slot](#)

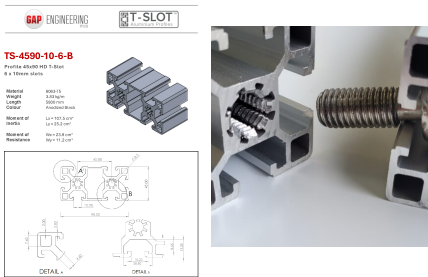
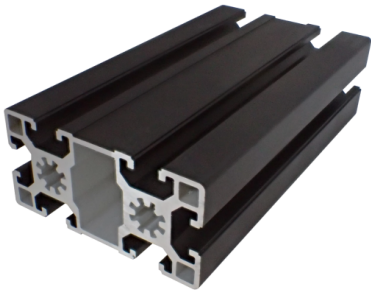

GAP ENGINEERING

T-SLOT

TS-4590-10-6-B

Profile 45x90x10 10mm slot

6 x 10mm slots

Material

Weight

Length

Colour

Weight of

Material

Weight of

Material

Weight of

Material

Weight of

Material

Weight of

Material

Weight of

Material

Weight of

Material

Weight of

Material

Weight of

Material

Weight of

Material

Weight of

Material

Weight of

Material

Weight of

Material

Weight of

Material

Weight of

Material

Weight of

Material

Weight of

Material

PROFILE 45X90 10MM SLOT ANODISED CLEAR

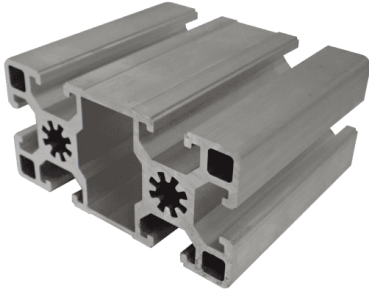

Price per meter

Product Code: TS-4590-10-6

Colour: Natural anodised

Bar Length: 5800 mm

[Read More](#)

SKU: N/A

Price: \$72.60 Ex GST per Meter

Categories: [45 Series](#), [T slot Aluminium Profiles](#), [T Slot profile and accessories](#)

Tags: [10mm Slot](#), [45 Series](#), [4590](#), [Aluminium Extrusion](#), [T-Rax Cargo System](#), [T-Slot](#)

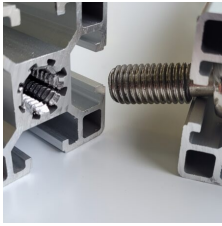
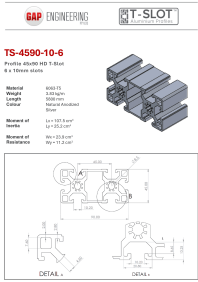

PROFILE 80X160 - 8MM SLOT ANODISED CLEAR

Price per meter

Product code: TS-80160-8-12

Colour: Natural anodized

Bar Length: 5800 mm

[Read More](#)

SKU: N/A

Price: \$178.20 Ex GST per Meter

Categories: [40 Series](#), [T slot Aluminium Profiles](#), [T Slot profile and accessories](#)

Tags: [40 Series](#), [80160](#), [8mm Slot](#), [Aluminium Extrusion](#), [Special Order](#), [T-Slot](#)

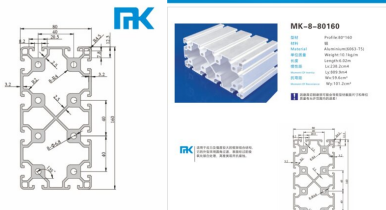

INDEX

1

16x40 T-Slot Aluminium Profile | 8mm & 6mm Slots | Black | GAP Engineering 3

16x40 T-Slot Aluminium Profile | 8mm & 6mm Slots | GAP Engineering 3

C

Cutting service 4

D

Drilling and tapping service 4

P

Profile 20x20 - 6mm slot Anodised Black 5

Profile 20x20 - 6mm slot Anodised Clear 5

Profile 20x40 - 6mm slot Anodised Black 6

Profile 20x40 - 6mm slot Anodised Clear 6

Profile 20x60 - 6mm slot Anodised Clear 7

Profile 20x80 - 6mm slot Anodised Clear 7

Profile 30x120 - 8mm slot Anodised Clear 8

Profile 30x30 - 8mm 3-slot Anodised Black 8

Profile 30x30 - 8mm 3-slot Anodised Clear 9

Profile 30x30 - 8mm slot Anodised Black 9

Profile 30x30 - 8mm slot Anodised Clear 10

Profile 30x30R - 8mm slot Anodised Clear 10

Profile 30x60 - 8mm 4-slot closed face Anodised Black 11

Profile 30x60 - 8mm 4-slot closed face Anodised Clear 11

Profile 30x60 - 8mm slot Anodised Black 12

Profile 30x60 - 8mm slot Anodised Clear 12

Profile 40x120 - 8mm slot Anodised Clear 13

Profile 40x160 - 8mm slot Anodised Black 13

Profile 40x40 - 8 mm 2-slot half closed Anodised Clear 14

Profile 40x40 - 8mm 3-slot closed face Anodised Clear 14

Profile 40x40 - 8mm slot Anodised Black 15

Profile 40x40 - 8mm slot Anodised Clear 15

Profile 40x40 R - 8mm slot Anodised Clear 16

Profile 40x80 - 8mm slot Anodised Black 16

Profile 40x80 - 8mm slot Anodised Clear 17

Profile 45x45 10mm slot Anodised Black 17

Profile 45x45 10mm slot Anodised Clear 18

Profile 45x90 10mm slot Anodised Black 18

Profile 45x90 10mm slot Anodised Clear 19

Profile 80x160 - 8mm slot Anodised Clear 19